

Westwood electrodes & insulators
 HIGH DIELECTRIC STRENGTH • PRECISION DIMENSIONS

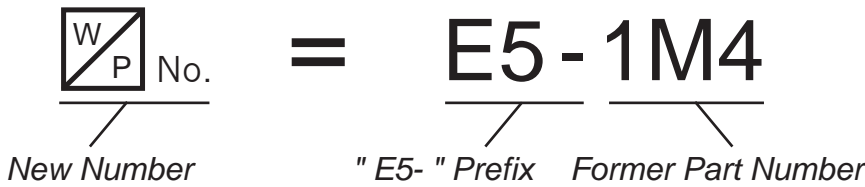

NOTE: Electrode and related items part numbers are now "E5-" followed by the former number.

Example:



Type 1M

Insulator length	W/P No.
4"	E5-1M4
4-1/4"	E5-1M4-1/4
4-1/2"	E5-1M4-1/2
5"	E5-1M5
6"	E5-1M6
7"	E5-1M7
8"	E5-1M8

Type 2M

Insulator length	W/P No.
4"	E5-2M4
4-1/2"	E5-2M4-1/2
5"	E5-2M5
5-1/2"	E5-2M5-1/2
6"	E5-2M6
7"	E5-2M7
8"	E5-2M8

Type 3M

Insulator length	W/P No.
4"	E5-3M4
4-1/2"	E5-3M4-1/2
5"	E5-3M5
5-1/2"	E5-3M5-1/2
6"	E5-3M6
7"	E5-3M7
8"	E5-3M8

Type 4M

Insulator length	W/P No.
4"	E5-4M4
4-1/4"	E5-4M4-1/4
4-1/2"	E5-4M4-1/2
5"	E5-4M5
6"	E5-4M6
7"	E5-4M7
8"	E5-4M8

Type 5M

Insulator length	W/P No.
4"	E5-5M4
5"	E5-5M5
6"	E5-5M6

Type 2F

Insulator length	W/P No.
4"	E5-2F4
4-1/2"	E5-2F4-1/2
5"	E5-2F5
5-1/2"	E5-2F5-1/2
6"	E5-2F6
7"	E5-2F7
8"	E5-2F8

Type 3F

Insulator length	W/P No.
4"	E5-3F4
4-1/2"	E5-3F4-1/2
5"	E5-3F5
5-1/2"	E5-3F5-1/2
6"	E5-3F6
7"	E5-3F7
8"	E5-3F8

Note: To order the insulator only for any electrode found on this page, add "INS" to the part number.



Westwood electrodes & insulators

HIGH DIELECTRIC STRENGTH • PRECISION DIMENSIONS

<p>"A" Ace 5" E5-100 Ace 6" E5-100B Ace 7" E5-100C</p>	<p>ABC (with bracket) E5-130</p>	<p>ABC E5-147</p> <p>ABC E5-148</p>
<p>Acme E5-102A</p>	<p>ABC (with bracket) E5-130A</p>	<p>ABC E5-148A</p>
<p>Acme E5-102B</p>	<p>ABC (with bracket) E5-130A</p>	<p>ABC E5-148B</p>
<p>Acme E5-107</p>	<p>"A" ABC 4" E5-131A ABC 5" E5-132A</p>	<p>ABC E5-148C</p>
<p>Aero E5-109</p>	<p>"A" ABC 4" E5-131A ABC 5" E5-132A</p>	<p>ABC ← with 6" spring E5-148K</p>
<p>Aero E5-110</p>	<p>"A" ABC 4" E5-131 ABC 5" E5-132</p>	<p>ABC E5-148M</p>
<p>Aero E5-110B</p>	<p>"A" ABC 4" E5-131 ABC 5" E5-132</p>	<p>ABC Sunray OE-1 E5-148Q</p>
<p>"A" Aero none E5-111A Aero 9-1/2" E5-111D Aero 13-1/2" E5-111E Aero 4-3/4" E5-111F Aero 7-1/2" E5-111G</p>	<p>ABC E5-133</p>	<p>"B" "C" "A" ABC Sunray 7/16" 3-1/4" 3/4" E5-148R ABC Sunray 7/16" 4-1/4" 1/4" E5-148R1 ABC Sunray 15/16" 3-1/4" 3/4" E5-148S</p>
<p>Arco E5-123</p>	<p>"A" ABC 1-1/2" E5-137B ABC 4-1/4" E5-137C ABC 7-1/2" E5-137E</p>	<p>Beckett E5-151A</p>
<p>Arco E5-126</p>	<p>"A" ABC 6" E5-144A ABC 5" E5-144B ABC 4-1/2" E5-144C ABC 4" E5-144D ABC 3" E5-144E ABC 2" E5-144F ABC 1-3/4" E5-144G ABC None E5-144H</p>	<p>Beckett E5-151B</p>
<p>Arco E5-127</p>	<p>ABC E5-146</p>	<p>Beckett E5-151C</p>
<p>Arco E5-127A</p>	<p>"A" ABC 4-1/4" E5-146A ABC none E5-146B ABC 4-1/2" E5-146C</p>	<p>Beckett E5-151D</p>
<p>Armstrong E5-128</p>	<p>"A" ABC 4-1/4" E5-146A ABC none E5-146B ABC 4-1/2" E5-146C</p>	<p>Beckett E5-151E</p>
	<p>spring Beckett E5-151E1</p>	<p>spring Beckett E5-151E1</p>

Westwood electrodes & insulators

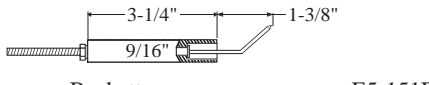
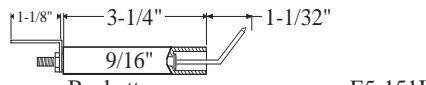
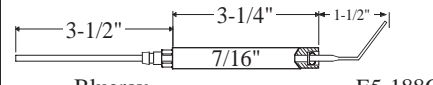
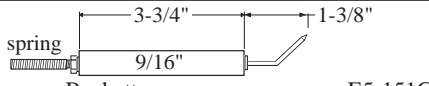
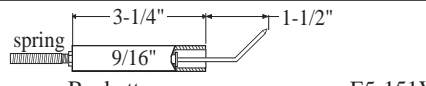
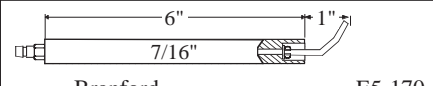
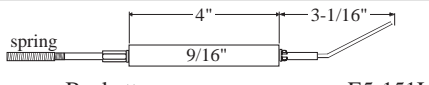
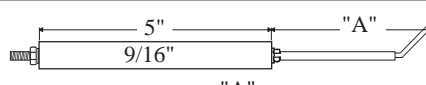
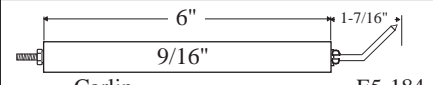
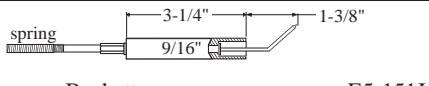
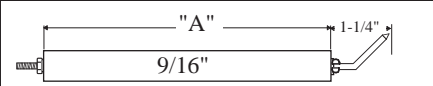
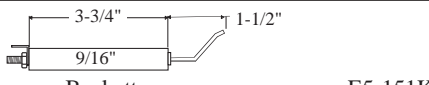
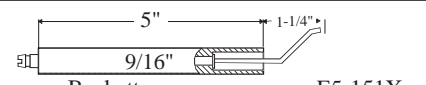
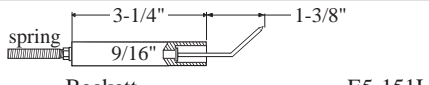
HIGH DIELECTRIC STRENGTH • PRECISION DIMENSIONS

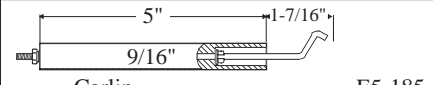
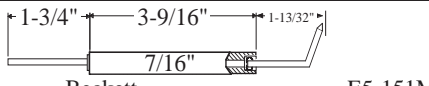
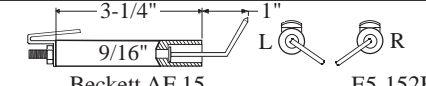
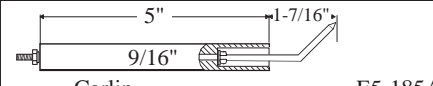
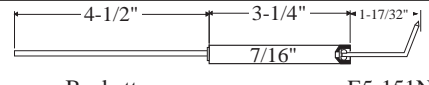
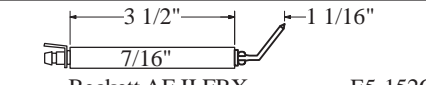
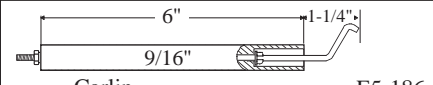
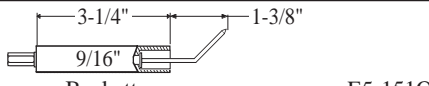
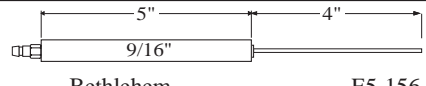
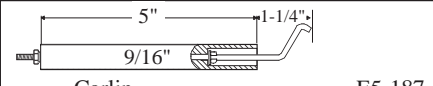
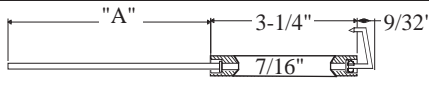
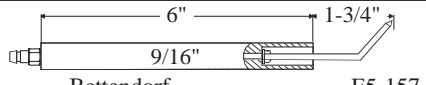
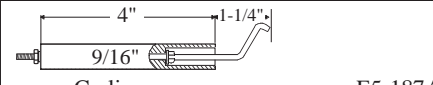
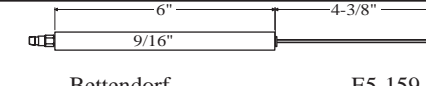
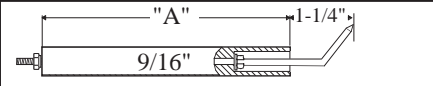
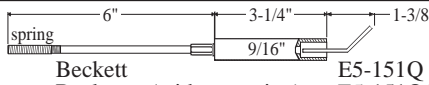
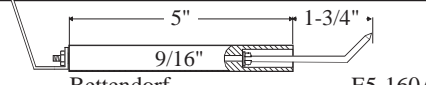
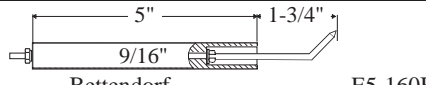
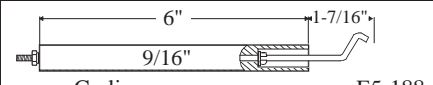
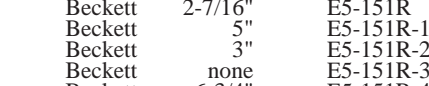
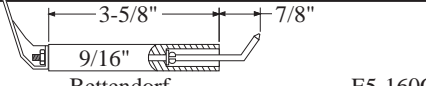
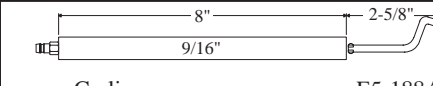
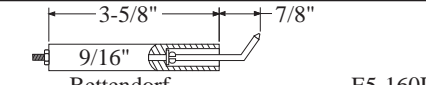
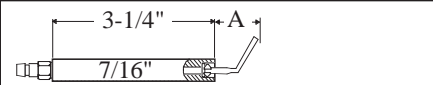
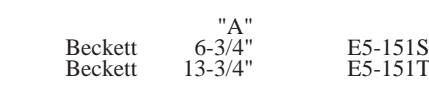
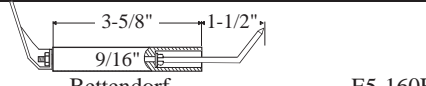
 Beckett E5-151F	 Beckett E5-151U	 Blueray E5-1880
 Beckett E5-151G	 Beckett E5-151V	 Branford E5-170
 Beckett E5-151I	 Beckett E5-151A	 Carlin E5-184
 Beckett E5-151J	Beckett 1-1/4" E5-151 Beckett 3-1/4" E5-152 Beckett 5" E5-152A Beckett 6-1/4" E5-153 Beckett 1-1/2" E5-153A	 Carlin E5-184A-C
 Beckett E5-151K	 Beckett E5-151X	Carlin "A" E5-184A Carlin 4" E5-184B Carlin 5" E5-184C Carlin 6" E5-184C
 Beckett E5-151L	 Beckett AF II HLX E5-151Z	 Carlin E5-185
 Beckett E5-151M	 Beckett AF 15 E5-152B	 Carlin E5-185A
 Beckett E5-151N	 Beckett AF II FBX E5-152C	 Carlin E5-186
 Beckett E5-151O	 Bethlehem E5-156	 Carlin E5-187
 Beckett E5-151P	 Bettendorf E5-157	 Carlin E5-187A
Beckett "A" E5-151P Beckett 5" E5-151P1 Beckett 2" E5-151P2 Beckett 3/4" E5-151P2	 Bettendorf E5-159	 Carlin E5-187B-C
 Beckett E5-151Q	 Bettendorf E5-160A	Carlin "A" E5-187B Carlin 5" E5-187C Carlin 6" E5-187C
Beckett (without spring) E5-151Q1	 Bettendorf E5-160B	 Carlin E5-188
 Beckett E5-151R-1 Beckett E5-151R-2 Beckett E5-151R-3 Beckett E5-151R-4	 Bettendorf E5-160C	 Carlin E5-188A
Beckett "A" E5-151R Beckett 2-7/16" E5-151R-1 Beckett 5" E5-151R-2 Beckett 3" E5-151R-3 Beckett none E5-151R-3 Beckett 6-3/4" E5-151R-4	 Bettendorf E5-160D	 Carlin E5-188B-E
 Beckett E5-151S	 Bettendorf E5-160E	Carlin "A" E5-188B Carlin 7/8" E5-188B Carlin 1-9/16" E5-188B2
Beckett 6-3/4" E5-151S Beckett 13-3/4" E5-151T		

Westwood electrodes & insulators

HIGH DIELECTRIC STRENGTH • PRECISION DIMENSIONS

 Carlin E5-188C	 Carlin E5-188O	 Cleanburn E5-199Z1																
 Carlin E5-188D	 Carlin E5-188P																	
 Carlin E5-188E	 Carlin E5-188Q	 Cleaver Brooks E5-201																
 Carlin E5-188F	 Carlin E5-188R2	 Cleaver Brooks E5-203																
 Carlin E5-188G	<table border="0"> <tr> <td></td> <td>"A"</td> <td>"B"</td> <td></td> </tr> <tr> <td>Carlin</td> <td>7/8"</td> <td>12"</td> <td>E5-188R2</td> </tr> <tr> <td>Carlin</td> <td>1-9/16"</td> <td>12"</td> <td>E5-188R3</td> </tr> <tr> <td>Carlin</td> <td>7/8"</td> <td>15"</td> <td>E5-188R4</td> </tr> </table>		"A"	"B"		Carlin	7/8"	12"	E5-188R2	Carlin	1-9/16"	12"	E5-188R3	Carlin	7/8"	15"	E5-188R4	 Cleaver Brooks E5-204A
	"A"	"B"																
Carlin	7/8"	12"	E5-188R2															
Carlin	1-9/16"	12"	E5-188R3															
Carlin	7/8"	15"	E5-188R4															
 Carlin E5-188H	 Century E5-189	 Cleaver Brooks E5-205																
 Carlin E5-188I LH/RH	 Century E5-191	 Cleaver Brooks E5-205A																
 Carlin E5-188J LH/RH	 Century E5-191A	<table border="0"> <tr> <td>Cleaver Brooks</td> <td>"A"</td> <td>E5-205A</td> </tr> <tr> <td>Cleaver Brooks</td> <td>3"</td> <td>E5-205A5</td> </tr> <tr> <td>Cleaver Brooks</td> <td>4-3/4"</td> <td>E5-205A5</td> </tr> </table>	Cleaver Brooks	"A"	E5-205A	Cleaver Brooks	3"	E5-205A5	Cleaver Brooks	4-3/4"	E5-205A5							
Cleaver Brooks	"A"	E5-205A																
Cleaver Brooks	3"	E5-205A5																
Cleaver Brooks	4-3/4"	E5-205A5																
 Carlin E5-188K LH/RH	 Century E5-191B	 Cleaver Brooks E5-205A1																
 Carlin E5-188L	 Chief E5-192	 Cleaver Brooks E5-205A2																
 Carlin E5-188M	 Chief E5-192B	 Cleaver Brooks E5-205B																
 Carlin E5-188N	 Clayton E5-198	 Cleaver Brooks E5-205D																
 Carlin E5-188N2	 Clayton E5-199	 Cleaver Brooks E5-205E																
 Carlin E5-188N1	 Clayton E5-199A	 Cleaver Brooks E5-205E2																
 Carlin E5-188N3	 Clayton E5-199D	 Cleaver Brooks E5-205F																
 Carlin E5-188N5	 Cleanburn E5-199Z	 Cleaver Brooks E5-205G																
 Carlin E5-188N6		 Cleaver Brooks E5-205H																
 Carlin E5-188N8		 Cleaver Brooks E5-205I																
 Carlin E5-188N9		 Cleaver Brooks E5-205J																
 Carlin E5-188N4		 Cleaver Brooks E5-205K																
 Carlin E5-188N7		 Cleaver Brooks E5-205L																
 Carlin E5-188N10		 Cleaver Brooks E5-205M																
		 Cleaver Brooks E5-205N																

Westwood electrodes & insulators

HIGH DIELECTRIC STRENGTH • PRECISION DIMENSIONS

<p>Cleaver Brooks E5-205T</p>	<p>Delco E5-225</p>	<p>Dravo E5-232N</p>
<p>Cleaver Brooks E5-205U</p>	<p>Delco E5-227</p>	<p>Dravo E5-233</p>
<p>Cleaver Brooks E5-205V</p>	<p>Delco E5-228</p>	<p>Ducane "A" none E5-234A Ducane 1-7/8" E5-234B Ducane 3-7/8" E5-234C Ducane 5-7/8" E5-234D</p>
<p>Cleaver Brooks E5-205X</p>	<p>Dravo E5-232</p>	<p>Ducane "A" none E5-234E Ducane 2-1/4" E5-234F Ducane 4-1/4" E5-234G Ducane 6-1/4" E5-234H Ducane 12-1/4" E5-234I Ducane 20-1/4" E5-234J</p>
<p>Cleaver Brooks E5-205Y</p>	<p>Dravo E5-232A</p>	<p>Ducane "A" none E5-234K Ducane 2-3/4" E5-234L Ducane 4-3/4" E5-234M</p>
<p>Cleaver Brooks E5-205Z</p>	<p>Dravo E5-232B</p>	<p>Ducane "A" none E5-234M</p>
<p>Cleaver Brooks E5-205Z2</p>	<p>Dravo E5-232C</p>	<p>Ducane "A" none E5-234L Ducane 2-3/4" E5-234M Ducane 4-3/4" E5-234M</p>
<p>Cleaver Brooks E5-205Z3</p>	<p>Dravo E5-232D</p>	<p>Eclipse "A" none E5-235 Eclipse 7-3/4" E5-235A Eclipse 11" E5-235B Eclipse 15" E5-235B</p>
<p>Coleman E5-202A</p>	<p>Dravo E5-232E</p>	<p>Eclipse "A" none E5-236 Eclipse 7" E5-236 Eclipse 2-3/4" E5-236</p>
<p>Coleman E5-202B</p>	<p>Dravo E5-232F</p>	<p>Eclipse E5-237</p>
<p>Columbia Boiler E5-206</p>	<p>Dravo E5-232G</p>	<p>Eclipse E5-238</p>
<p>Columbia Boiler E5-207A</p>	<p>Dravo E5-232H</p>	<p>Eclipse E5-238B</p>
<p>Crane "A" none E5-213 Crane 6" E5-214</p>	<p>Dravo E5-232I</p>	<p>Economite E5-239</p>
<p>Delco E5-221</p>	<p>Dravo E5-232J</p>	<p>Economite E5-239A</p>
<p>Delco E5-224</p>	<p>Dravo E5-232K</p>	<p>Economite E5-239B</p>

Westwood electrodes & insulators

HIGH DIELECTRIC STRENGTH • PRECISION DIMENSIONS

<p>Economite E5-239C</p>	<p>Fulton Boiler E5-282A Fulton Boiler E5-282B</p>	<p>Gordon Piatt E5-307B Gordon Piatt E5-307C Gordon Piatt E5-307D</p>
<p>Economite E5-239D</p>	<p>Fulton Boiler E5-282C</p>	<p>Gordon Piatt E5-307F Gordon Piatt E5-307P Gordon Piatt E5-307G Gordon Piatt E5-307H</p>
<p>Economite E5-239E</p>	<p>Fulton Boiler E5-283A</p>	<p>Gordon Piatt E5-307I Gordon Piatt E5-307J</p>
<p>Economite E5-239F</p>	<p>Fulton Boiler E5-283B</p>	<p>Gordon Piatt E5-307K</p>
<p>Edison E5-246</p>	<p>Fulton Boiler E5-284</p>	<p>Gordon Piatt E5-307O</p>
<p>Edison E5-247</p>	<p>Fulton Boiler E5-285</p>	<p>Gordon Piatt E5-307Q Gordon Piatt E5-307R Gordon Piatt E5-307S</p>
<p>Electromagic E5-249A</p>	<p>General Automatic E5-290</p>	<p>General Electric E5-291</p>
<p>Enterprise E5-253B Enterprise E5-253C Enterprise E5-253D</p>	<p>Esso E5-258</p>	<p>General Electric E5-296</p>
<p>Esso E5-261</p>	<p>General Electric E5-298</p>	<p>Gordon Piatt E5-307U</p>
<p>Flame Guard E5-267A Flame Guard E5-267B Flame Guard E5-267C Flame Guard E5-267E Flame Guard E5-267F Flame Guard E5-267G</p>	<p>General Electric E5-299A</p>	<p>Gordon Piatt E5-307V</p>
<p>Flame Guard E5-267D</p>	<p>General Electric E5-301A</p>	<p>Gordon Piatt E5-307N Gordon Piatt E5-307T</p>
<p>Fulton Boiler E5-282 Fulton Boiler E5-283</p>	<p>General Electric E5-301B</p>	<p>Gould E5-308 Gould E5-309 Gould E5-310 Gould E5-311</p>
<p>Gold Star E5-306 Gold Star E5-307</p>	<p>Gordon Piatt E5-307W</p>	<p>Gordon Piatt E5-307X</p>



Westwood electrodes & insulators

HIGH DIELECTRIC STRENGTH • PRECISION DIMENSIONS

<p>Heil Heil "A" 2-1/4" 4" E5-330A E5-330B</p>	<p>International E5-348A</p>	<p>Iron Fireman E5-365D</p>
<p>Heil E5-331B</p>	<p>Iron Fireman E5-357</p>	<p>Iron Fireman E5-366D</p>
<p>Homelite E5-337A</p>	<p>Iron Fireman E5-357C</p>	<p>Johnson "A" 1-1/2" 2" 7-1/2" 6" E5-371 E5-371A E5-372 E5-374</p>
<p>Homestead E5-338</p>	<p>Iron Fireman E5-357D</p>	<p>Johnson E5-373</p>
<p>Homestead E5-340</p>	<p>Iron Fireman E5-357E</p>	<p>Johnson E5-373A</p>
<p>Homestead E5-341</p>	<p>Iron Fireman E5-357I</p>	<p>Johnson E5-375</p>
<p>Homestead E5-341A</p>	<p>Iron Fireman E5-357J</p>	<p>Johnson E5-375A</p>
<p>Industrial Combustion E5-342</p>	<p>Iron Fireman E5-357L</p>	<p>Johnson E5-377</p>
<p>Industrial Combustion E5-343</p>	<p>Iron Fireman E5-357M</p>	<p>Johnson Gas E5-377A</p>
<p>Industrial Combustion E5-343A</p>	<p>Iron Fireman E5-357O</p>	<p>Kewanee E5-378</p>
<p>Industrial Combustion E5-344</p>	<p>Iron Fireman E5-357R</p>	<p>Kewanee E5-378A</p>
<p>Industrial Combustion E5-344A</p>	<p>Iron Fireman E5-357S</p>	<p>Kewanee E5-378B</p>
<p>Industrial Combustion E5-345</p>	<p>Iron Fireman E5-357W</p>	<p>Kewanee E5-378C</p>
<p>Industrial Combustion E5-345A</p>	<p>Iron Fireman E5-357Y</p>	<p>Lenan E5-379I</p>
<p>International E5-348</p>	<p>Iron Fireman E5-364</p>	<p>La Salle E5-381</p>

Westwood electrodes & insulators

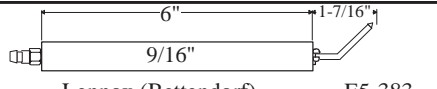
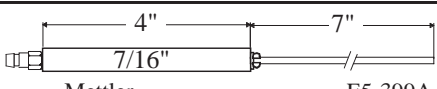
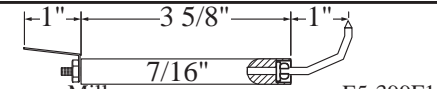
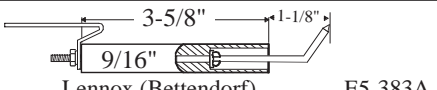
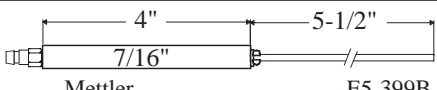
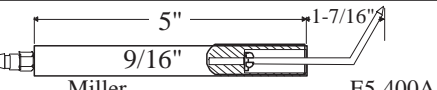
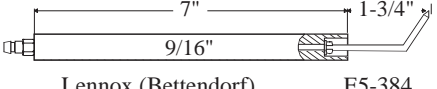
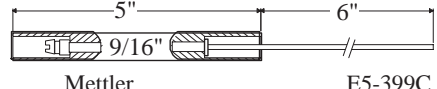
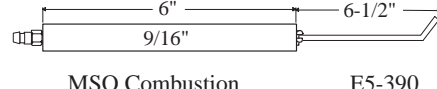
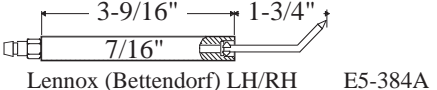
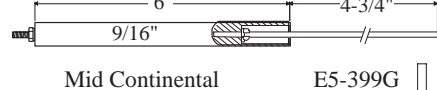
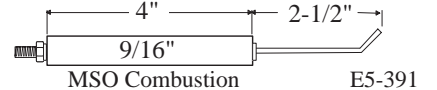
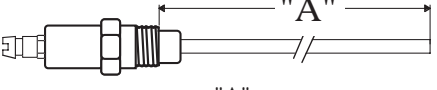
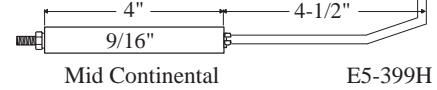
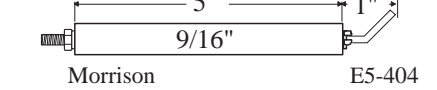
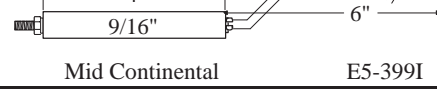
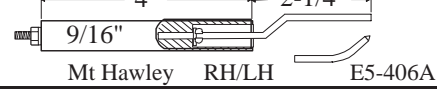
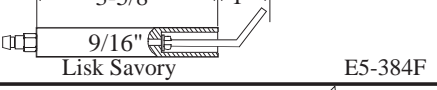
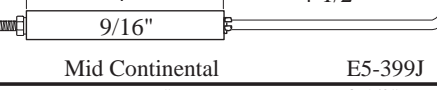
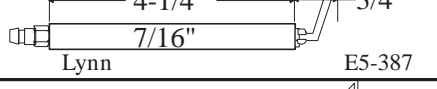
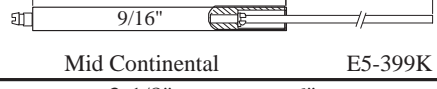
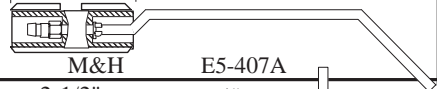
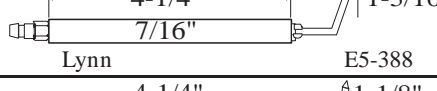
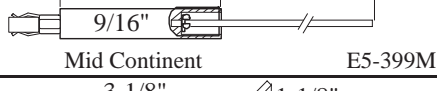
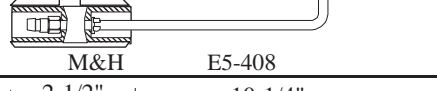
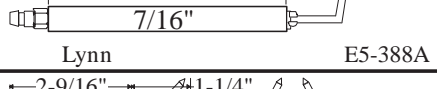
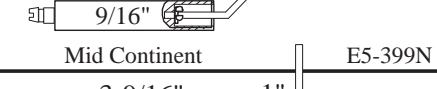
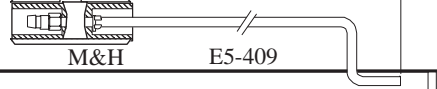
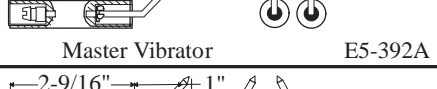
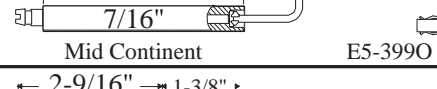
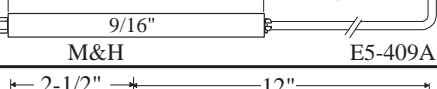
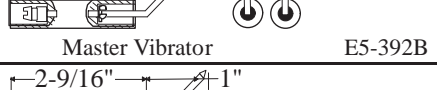
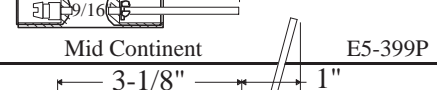
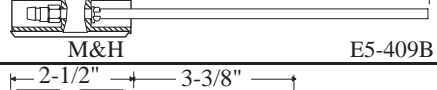
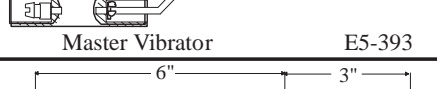
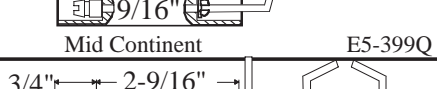
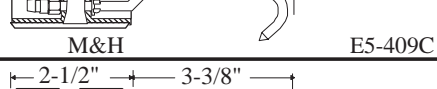
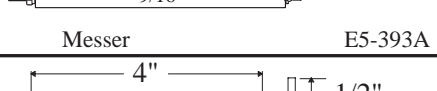
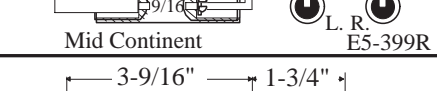
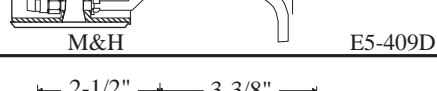
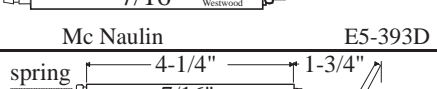
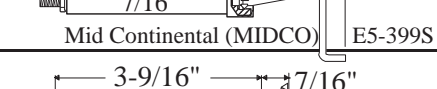
HIGH DIELECTRIC STRENGTH • PRECISION DIMENSIONS

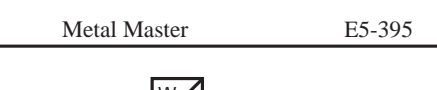
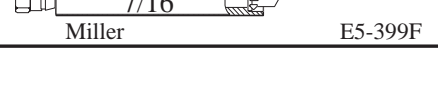
 Lennox (Bettendorf) E5-383	 Mettler E5-399A	 Miller E5-399F1
 Lennox (Bettendorf) E5-383A	 Mettler E5-399B	 Miller E5-400A
 Lennox (Bettendorf) E5-384	 Mettler E5-399C	 MSO Combustion E5-390
 Lennox (Bettendorf) LH/RH E5-384A	 Mid Continental E5-399G	 MSO Combustion E5-391
 "A" Lennox 2" E5-384C Lennox 4" E5-384D Lennox 6" E5-384E	 Mid Continental E5-399H	 Morrison E5-404
	 Mid Continental E5-399I	 Mt Hawley RH/LH E5-406A
	 Lisk Savory E5-384F	 Mid Continental E5-399J
 Lynn E5-387	 Mid Continental E5-399K	 M&H E5-407A
 Lynn E5-388	 Mid Continent E5-399M	 M&H E5-408
 Lynn E5-388A	 Mid Continent E5-399N	 M&H E5-409
 Master Vibrator E5-392A	 Mid Continent E5-399O	 M&H E5-409A
 Master Vibrator E5-392B	 Mid Continent E5-399P	 M&H E5-409B
 Master Vibrator E5-393	 Mid Continent E5-399Q	 M&H E5-409C
 Messer E5-393A	 Mid Continent E5-399R	 M&H E5-409D
 Mc Naulin E5-393D	 Mid Continental (MIDCO) E5-399S	 M&H (with Bracket) E5-409C-2
 Metal Master E5-395	 Miller E5-399F	

Westwood electrodes & insulators

HIGH DIELECTRIC STRENGTH • PRECISION DIMENSIONS

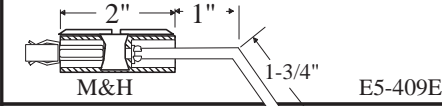
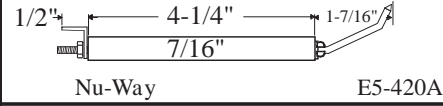
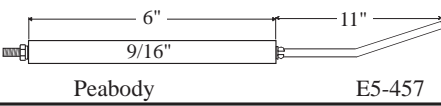
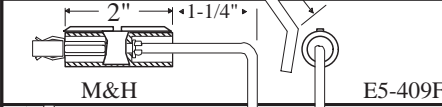
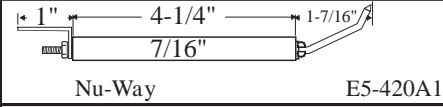
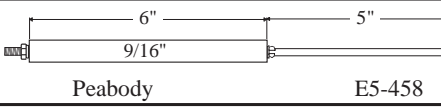
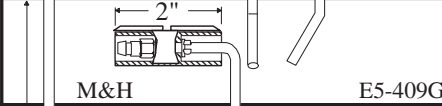
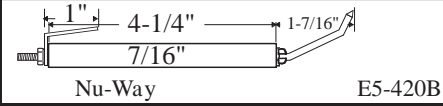
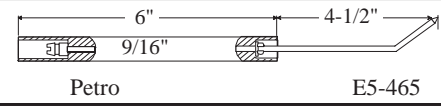
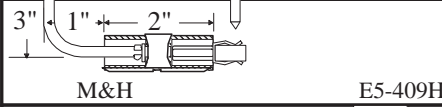
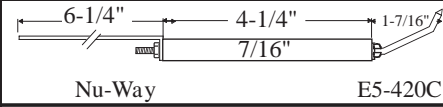
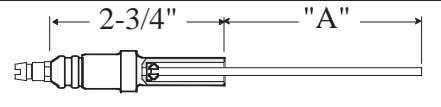
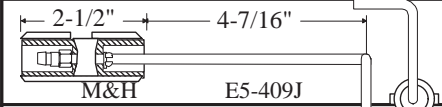
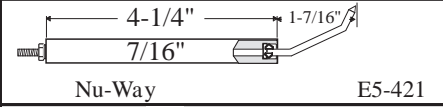
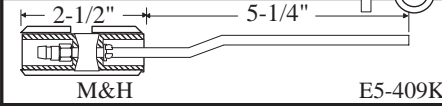
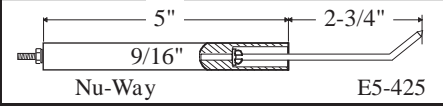
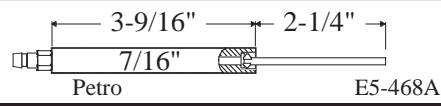
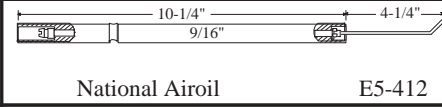
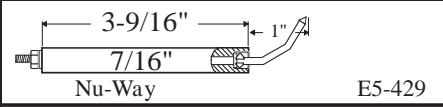
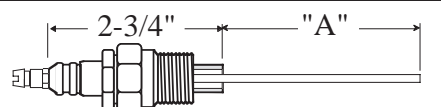
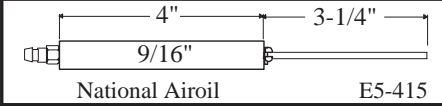
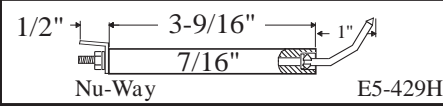
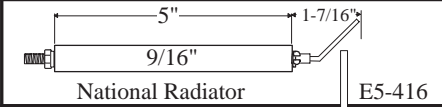
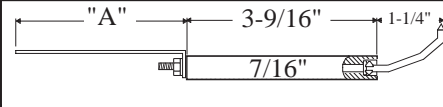
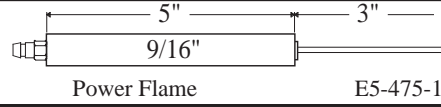
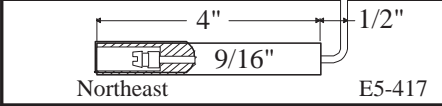
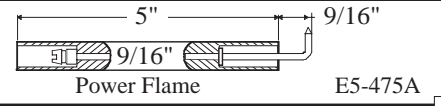
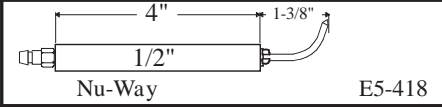
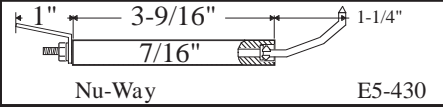
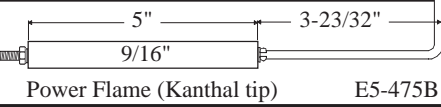
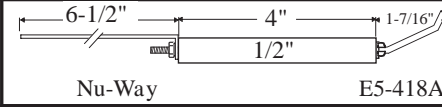
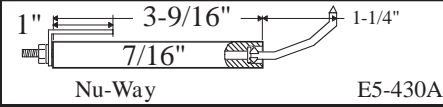
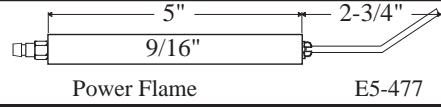
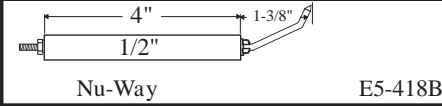
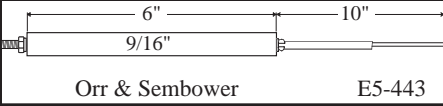
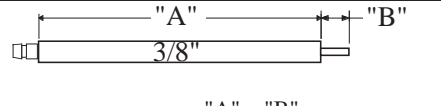
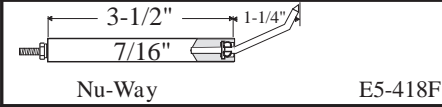
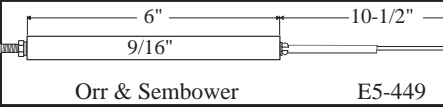
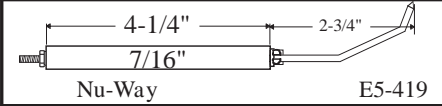
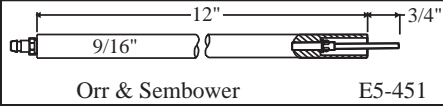
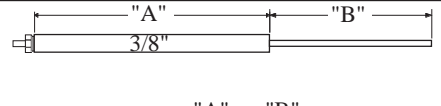
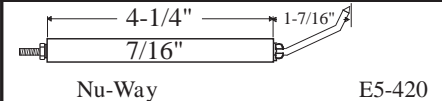
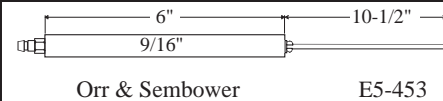
 M&H E5-409E	 Nu-Way E5-420A	 Peabody E5-457
 M&H E5-409F	 Nu-Way E5-420A1	 Peabody E5-458
 M&H E5-409G	 Nu-Way E5-420B	 Petro E5-465
 M&H E5-409H	 Nu-Way E5-420C	 Petro E5-467
 M&H E5-409J	 Nu-Way E5-421	Petro 1-1/2" E5-467 Petro 2" E5-467A Petro 18" E5-467B Petro 6" E5-467G
 M&H E5-409K	 Nu-Way E5-425	 Petro E5-468A
 National Airoil E5-412	 Nu-Way E5-429	 Petro E5-468B
 National Airoil E5-415	 Nu-Way E5-429H	Petro 1-1/2" E5-468B Petro 2" E5-468C Petro 18" E5-468D
 National Radiator E5-416	 Nu-Way E5-429A	 Power Flame E5-475-1
 Northeast E5-417	Nu-Way E5-429B 1/2" E5-429D 2" E5-429B 1" E5-429F 2-1/2" E5-429C 1-1/2" E5-429G 3-1/2"	 Power Flame E5-475A
 Nu-Way E5-418	 Nu-Way E5-430	 Power Flame (Kanthal tip) E5-475B
 Nu-Way E5-418A	 Nu-Way E5-430A	 Power Flame E5-477
 Nu-Way E5-418B	 Orr & Sembower E5-443	 Power Flame E5-477A
 Nu-Way E5-418F	 Orr & Sembower E5-449	Power Flame 5.81" .50" E5-477A Power Flame 6.44" .38" E5-477B Power Flame 6.88" .47" E5-477C
 Nu-Way E5-419	 Orr & Sembower E5-451	 Power Flame E5-477A-1
 Nu-Way E5-420	 Orr & Sembower E5-453	Power Flame 5.81" 6.30" E5-477A-1 Power Flame 6.44" 6.69" E5-477B-1 Power Flame 6.88" 8.66" E5-477C-1

Westwood electrodes & insulators

HIGH DIELECTRIC STRENGTH • PRECISION DIMENSIONS

<p>Power Flame E5-477D</p>	<p>Power Flame E5-479B</p>	<p>Ray E5-500</p>
<p>Power Flame E5-477E</p>	<p>Power Flame E5-479C</p>	<p>Ray E5-502</p>
<p>Power Flame E5-477F</p>	<p>Power Flame E5-479D</p>	<p>Ray E5-503A</p>
<p>Power Flame (Stainless tip) E5-477G</p>	<p>Power Flame E5-479E</p>	<p>Ray E5-503D</p>
<p>Power Flame E5-477H</p>	<p>Power Flame E5-479E1</p>	<p>Ray E5-503E</p>
<p>Power Flame E5-477I</p>	<p>Preferred Utilities E5-471A</p>	<p>Ray E5-503G</p>
<p>Power Flame E5-477J</p>	<p>PVI E5-473F</p>	<p>Ray E5-503H</p>
<p>Power Flame E5-477K</p>	<p>PVI E5-473G</p>	<p>Ray E5-503J</p>
<p>Power Flame E5-478</p>	<p>Pyronics E5-474C-1 6" E5-474C-2 12"</p>	<p>Ray E5-503M</p>
<p>Power Flame E5-478A</p>	<p>Pyronics E5-474E</p>	<p>Ray E5-503P</p>
<p>Power Flame E5-478B</p>	<p>Pyronics</p>	<p>Robert Gordon E5-506B</p>
<p>Power Flame E5-478C</p>	<p>Quiet Heat 4-1/4" E5-483 Quiet Heat 5" E5-483-5 Quiet Heat 6" E5-483-6</p>	<p>Robert Gordon E5-506C</p>
<p>Power Flame E5-478D</p>	<p>Radiant E5-490</p>	<p>Light Tip</p> <p>Shellhead 4" E5-513-4 Shellhead 5" E5-513-5 Shellhead 6" E5-513-6 Shellhead 7" E5-513-7 Shellhead 8" E5-513-8 Shellhead 9" E5-513-9 Shellhead 10" E5-513-10 Shellhead 11" E5-513-11 Shellhead 12" E5-513-12 Shellhead 13" E5-513-13 Shellhead 14" E5-513-14</p>
<p>Power Flame E5-478E</p>	<p>Rails E5-489B</p>	
<p>Power Flame E5-479</p>	<p>Rails E5-489C</p>	
<p>Power Flame E5-479A</p>	<p>Ray E5-499 3-3/4" E5-499C 5"</p>	



Please order by No.

rev. 3-9-17

E10



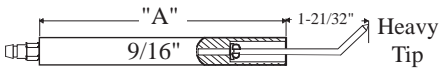
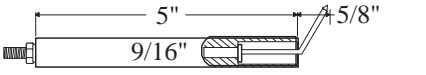
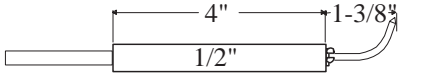
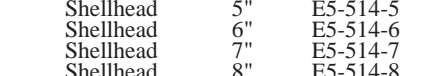
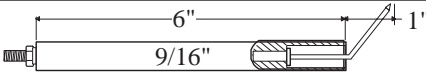
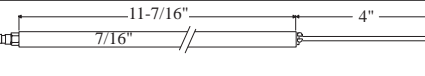
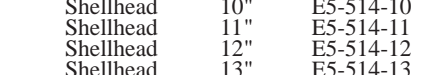
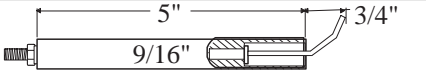
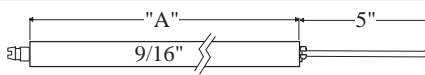
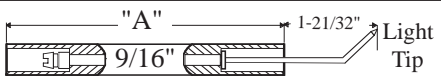
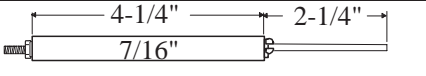
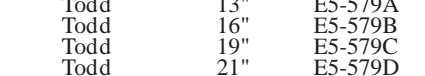
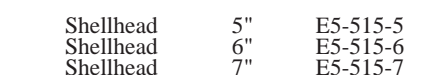
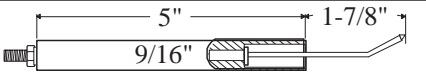
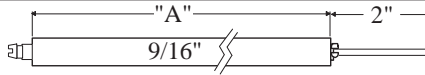
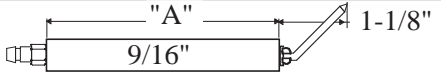
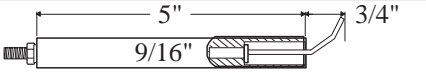
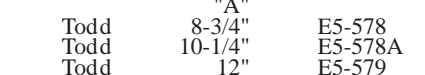

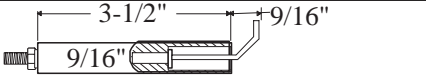
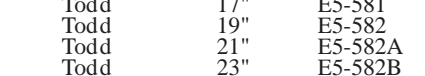
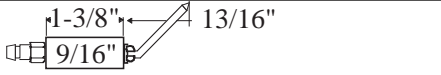
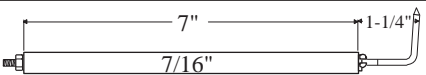
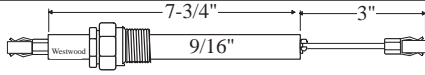
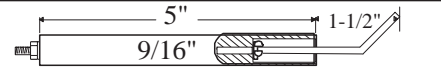
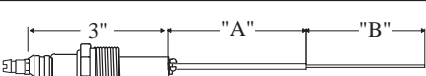
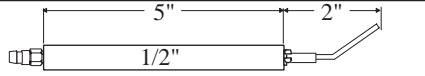
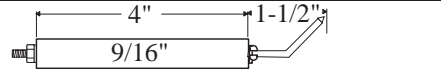
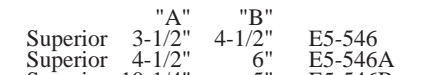
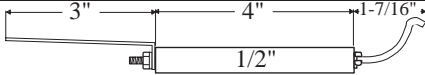
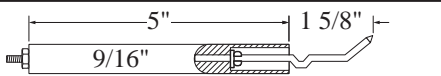
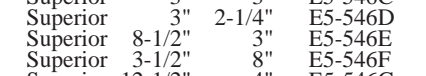
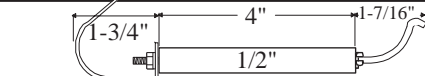
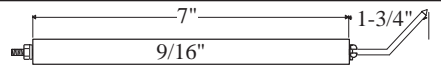
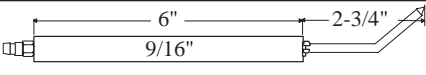
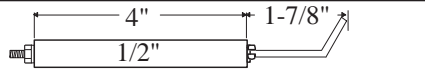
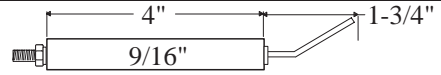
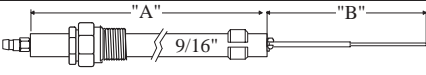
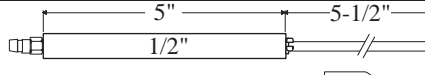

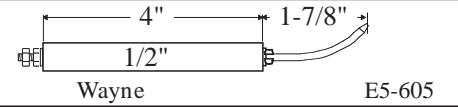
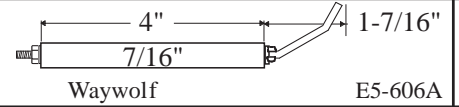
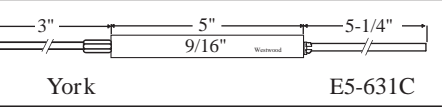
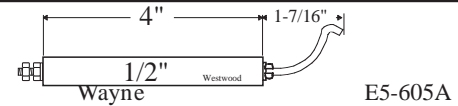
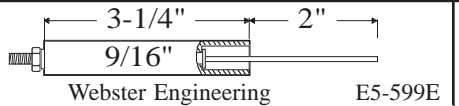
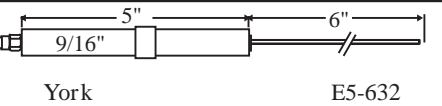
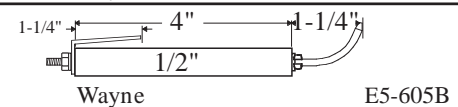
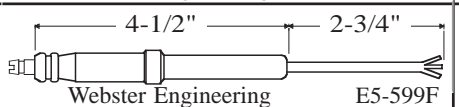
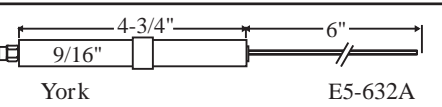
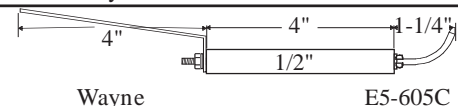
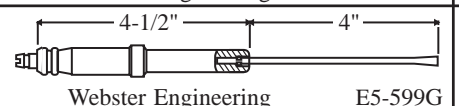
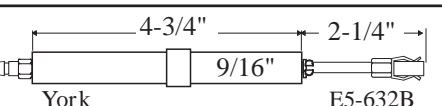
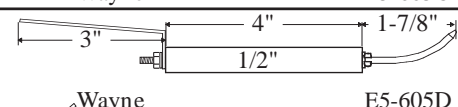
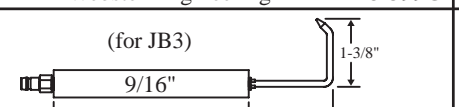
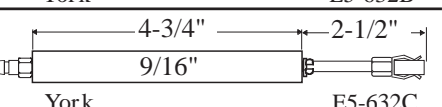
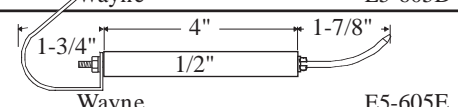
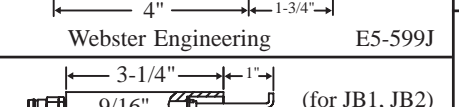
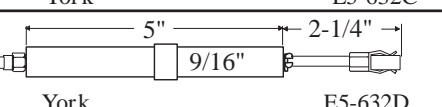
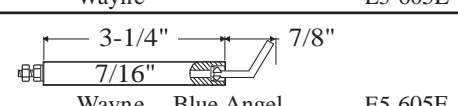
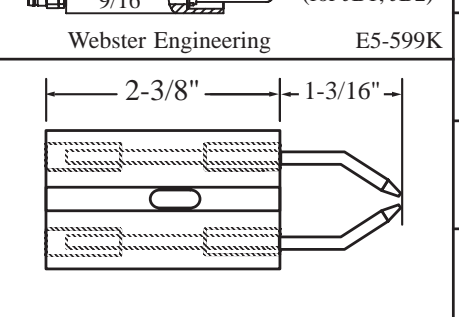
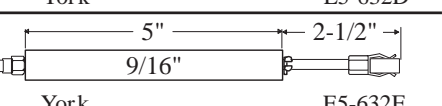
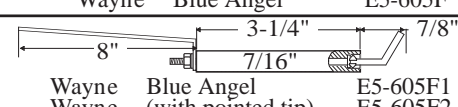
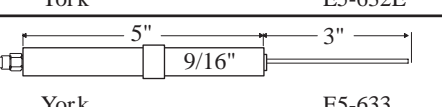
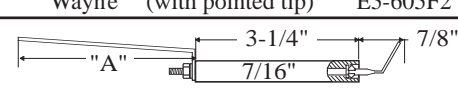
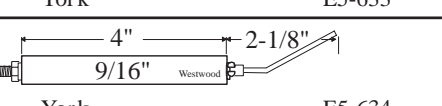
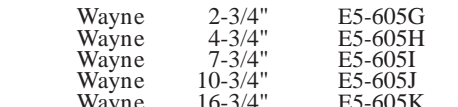
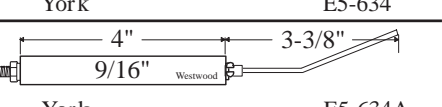
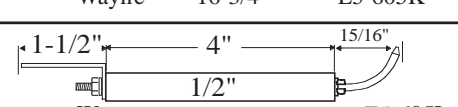
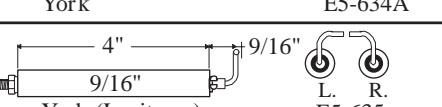
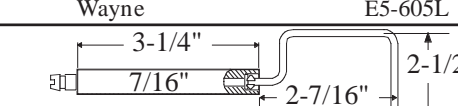
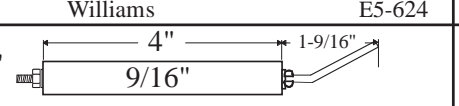
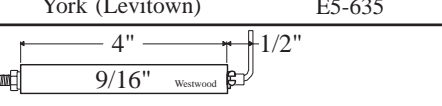
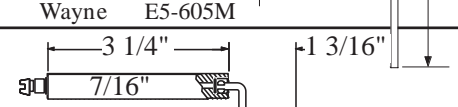
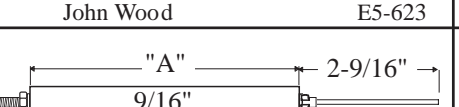
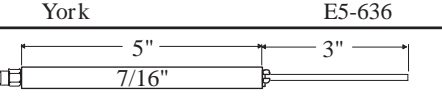

Westwood electrodes & insulators

HIGH DIELECTRIC STRENGTH • PRECISION DIMENSIONS

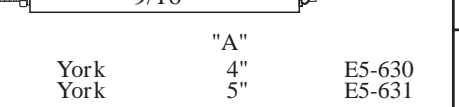
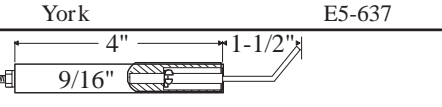
 <p>Shellhead 4" E5-514-4 Shellhead 5" E5-514-5 Shellhead 6" E5-514-6 Shellhead 7" E5-514-7 Shellhead 8" E5-514-8 Shellhead 9" E5-514-9 Shellhead 10" E5-514-10 Shellhead 11" E5-514-11 Shellhead 12" E5-514-12 Shellhead 13" E5-514-13 Shellhead 14" E5-514-14</p>	 <p>Sun Ray E5-559E</p>	 <p>Thatcher E5-560</p>
 <p>Sun Ray E5-559F</p>	 <p>Todd E5-577A</p>	 <p>Todd 13" E5-579A Todd 16" E5-579B Todd 19" E5-579C Todd 21" E5-579D Todd 22" E5-579E</p>
 <p>Sun Ray E5-559H</p>	 <p>Sun Ray E5-559J</p>	 <p>Todd 8-3/4" E5-578 Todd 10-1/4" E5-578A Todd 12" E5-579 Todd 14" E5-580 Todd 17" E5-581 Todd 19" E5-582 Todd 21" E5-582A Todd 23" E5-582B Todd 24" E5-582C</p>
 <p>Shellhead 5" E5-515-5 Shellhead 6" E5-515-6 Shellhead 7" E5-515-7 Shellhead 8" E5-515-8</p>	 <p>Sun Ray E5-559K</p>	 <p>Sun Ray E5-559L</p>
 <p>Silent Glow 3" E5-523 Silent Glow 4" E5-524 Silent Glow 5" E5-525 Silent Glow 6" E5-526 Silent Glow 11-3/4" E5-527</p>	 <p>Sun Ray E5-559M</p>	 <p>Tornado Todd E5-588B</p>
 <p>Silent Glow E5-523A</p>	 <p>Sun Ray E5-559N</p>	 <p>Volcano E5-590</p>
 <p>Stewart Warner E5-545</p>	 <p>Superior 3-1/2" "A" 4-1/2" "B" E5-546 Superior 4-1/2" "A" 6" "B" E5-546A Superior 10-1/4" "A" 5" "B" E5-546B Superior 3" "A" 3" "B" E5-546C Superior 3" "A" 2-1/4" "B" E5-546D Superior 8-1/2" "A" 3" "B" E5-546E Superior 3-1/2" "A" 8" "B" E5-546F Superior 12-1/2" "A" 4" "B" E5-546G</p>	 <p>Wayne E5-601A</p>
 <p>Sun Ray E5-550</p>	 <p>Sun Ray E5-553</p>	 <p>Wayne E5-601B</p>
 <p>Sun Ray E5-557</p>	 <p>Superior E5-547</p>	 <p>Wayne E5-604</p>
 <p>Sun Ray E5-558</p>	 <p>Superior 14-3/4" "A" 5" "B" E5-547A Superior 18-1/2" "A" 3-3/4" "B" E5-547B Superior 16-1/2" "A" 3-1/4" "B" E5-547C Superior 13-1/2" "A" 3" "B" E5-547E</p>	 <p>Wayne E5-604A</p>
 <p>Sun Ray E5-559</p>	 <p>Superior Bulkhead E5-547D</p>	 <p>Wayne E5-604B</p>
 <p>Sun Ray E5-559B</p>	 <p>Superior E5-547F</p>	 <p>Wayne E5-604C</p>
 <p>Sun Ray E5-559D</p>	 <p>Wayne E5-604D</p>	 <p>Wayne E5-604D</p>

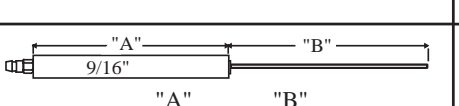
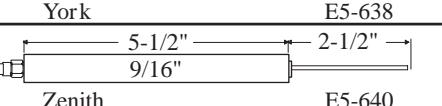
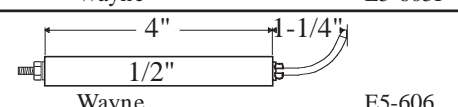
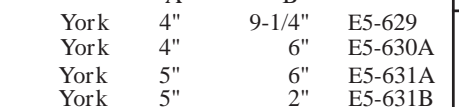
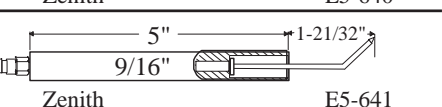
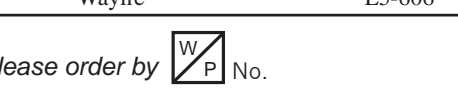
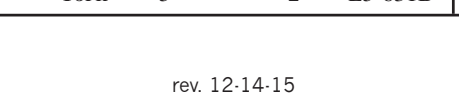
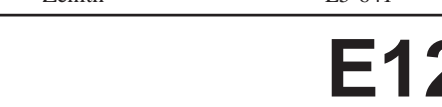
Westwood electrodes & insulators

HIGH DIELECTRIC STRENGTH • PRECISION DIMENSIONS

 Wayne E5-605	 Waywolf E5-606A	 York E5-631C
 Wayne E5-605A	 Webster Engineering E5-599E	 York E5-632
 Wayne E5-605B	 Webster Engineering E5-599F	 York E5-632A
 Wayne E5-605C	 Webster Engineering E5-599G	 York E5-632B
 Wayne E5-605D	 (for JB3) Webster Engineering E5-599J	 York E5-632C
 Wayne E5-605E	 (for JB1, JB2) Webster Engineering E5-599K	 York E5-632D
 Wayne Blue Angel E5-605F	 Weil-McLain, electrode only E5-598 Weil-McLain electrode w/leads E5-598A Leads only (former WMK-150) E5-598B	 York E5-632E
 Wayne Blue Angel E5-605F1		 York E5-633
 Wayne Blue Angel (with pointed tip) E5-605F2		 York E5-634
 Wayne E5-605G		 York E5-634A
 Wayne E5-605H		 York E5-635
 Wayne E5-605I	 Williams E5-624	 York (Levittown) E5-636
 Wayne E5-605J	 John Wood E5-623	 York E5-637
 Wayne E5-605K	 York E5-630	 York E5-631
 Wayne E5-605L	 York E5-631	 York E5-638
 Wayne E5-605M	 York E5-629	 York E5-639A
 Wayne E5-605N	 York E5-630A	 York E5-631A
 Wayne E5-605P	 York E5-631B	 Zenith E5-640
 Wayne E5-606	 York E5-629	 Zenith E5-641

Please order by  No.

rev. 12-14-15

E12

Westwood

ELECTRODE KITS

FOR THE SERVICE PROFESSIONAL

**ELECTRODE & INSULATOR KITS****Serviceman's Deluxe Kit****OEM Electrodes - 2 ea.**

ABC: E5-146

Beckett: E5-151E, E5-1510

Carlin: E5-188B, E5-188N, E5-188K

Quiet Heat: E5-483

Wayne: E5-604, E5-605, E5-605B,
E5-605F, E5-606**Rajah™ Terminals - 10 ea.**

E9-CT, E9-SS, E9-R-2, E9-RAC, E9-SF,

E9-BS 6-32, E9-BS 10-32,

E9-HS 6-32 (5 ea.), E9-HS 10-32 (5 ea.),
6-32 nut, 10-32 nut**Standard Electrodes - 2 ea.**E5-1M4, E5-2M4, E5-2M5, E5-2M6,
E5-4M4, E5-3M4, E5-3M5, E5-3M6**Also includes**

5 feet of GTO-15 ignition cable

1 set (2) T100-230 electrode benders

1 - T100-220 electrode gauge

1 set (2) T100-70 jumpers

1 - NAS gauge™ nozzle gauge

1 - Coupler Popper™ tool

1 - Plastic carrying case

 No. E5-2001
Serviceman's Super KitsSame contents as the E5-2001 Deluxe Kit, less the NAS gauge™ and Coupler Popper™
in a plastic carrying case
 No. E5-1897
Same contents as the E5-2001 Deluxe Kit, less the NAS gauge™ and Coupler Popper™
in a cardboard box
 No. E5-1897-C
ELECTRODE & INSULATOR ROLL-UP KITS**Contains:****Electrodes - 2 ea.**

E5-3M4 (9/16"x4"), E5-3M5 (9/16"x5"),

E5-3M6 (9/16"x6"), E5-3F5 (9/16"x5"),

E5-483 (Quiet Heat)

Insulators - 2 ea.

E5-1M4-1/4 (7/16"x4-1/4"), E5-4M4 (1/2"x4"),

E5-2M4 (9/16"x4"), E5-2M5 (9/16"x5"),

E5-3M4 (9/16"x4")

 No. E5-595
Contains:**Electrodes - 2 ea.**

E5-188N (Carlin), E5-151E (Beckett),

E5-605 (Wayne), E5-2M4 (9/16"x4"),

E5-2M5 (9/16"x5"), E5-2M6 (9/16"x6"),

E5-2F5 (female 5"), E5-2F6 (female 6")

Insulators - 2 ea.

E5-1M4-1/4 (7/16"x4-1/4"), E5-3M4 (9/16"x4"),

E5-2M4 (9/16"x4"), E5-2M5 (9/16"x5"),

E5-2M6 (9/16"x6"), E5-2F5 (female 5"),

E5-2F6 (female 6"), E5-4M4 (1/2"x4")

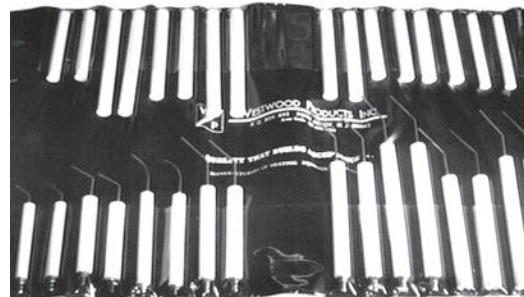
 No. E5-920

Westwood

ELECTRODE KITS

FOR THE SERVICE PROFESSIONAL

**ELECTRODE & INSULATOR ROLL-UP KITS (Continued)**

For Servicing
Beckett Burners

Contains these electrodes:

4 · E5-151E	2 · E5-151D
2 · E5-151E1	2 · E5-151R
2 · E5-151O	2 · E5-151G
2 · E5-151F	2 · E5-151J
2 · E5-151	



 No. E5-BK-400

For Servicing
Carlin Burners

Contains these electrodes:

4 · E5-188N	2 · E5-188P
4 · E5-188B	2 · E5-188Q
2 · E5-188K	2 · E5-188R3
2 · E5-188R-2	2 · E5-188N4
2 · E5-188H	



 No. E5-CK-300

For Servicing
Wayne Burners

Contains these electrodes:

4 · E5-605	2 · E5-605E
4 · E5-606	2 · E5-605C
2 · E5-605B	2 · E5-605D
2 · E5-605F	2 · E5-605F1
2 · E5-604	



 No. E5-WK-500

 Take a look . . .

PORCELAIN CUTTER No. T100-370 on page T17
&
RAJAH TERMINAL KITS on page E28

Please order by  No.

rev. 6-13-18

E14

Westwood
AUBURN IGNITION PRODUCTS

IGNITORS • FLAME RODS • LIQUID LEVEL ELECTRODES

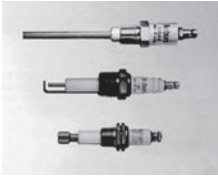

NOTE: Auburn ignition products part numbers are now "E5-" followed by the former number.

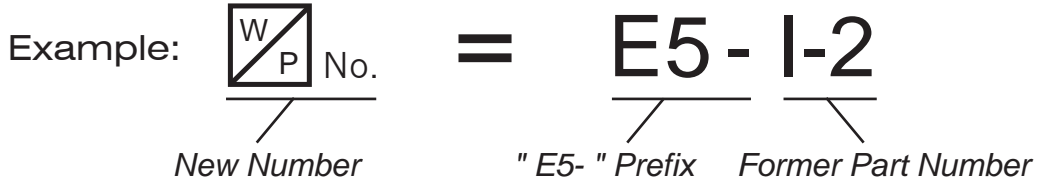

149T-1 (.090)

No.	Ref. No.
E5-149T-1-090	149T-1-090

I-2-EI-2

No.	Ref. No.
E5-I-2-EI-2	I-2-EI-2

F-68

No.	Ref. No.
E5-F-68	F-68

I-2 Series

No.	Ref. No.	"A" DIM.	"B" DIM.
E5-I-2	I-2	8.00	4.50
E5-I-2-1	I-2-1	15.50	12.00
E5-I-2-2	I-2-2	27.50	24.00

F-140

No.	Ref. No.
E5-F-140	

New!

* Dimensions marked with an asterisk are standard lengths - Other lengths available upon request

AUBURN ELECTRODES

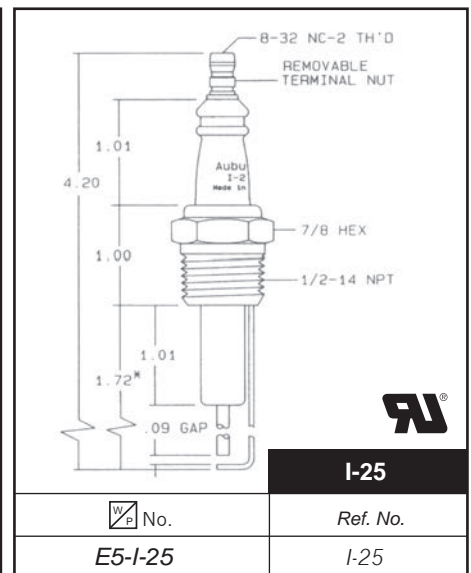
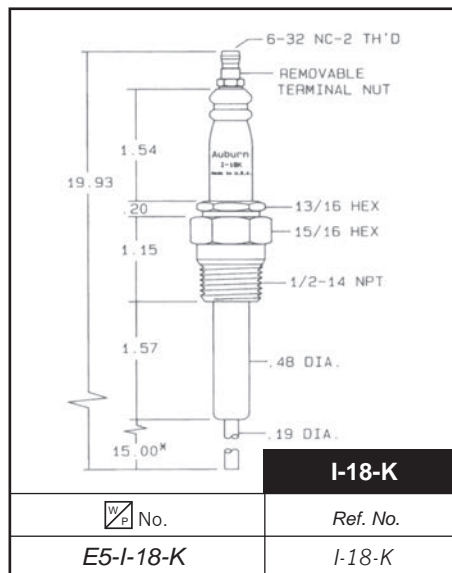
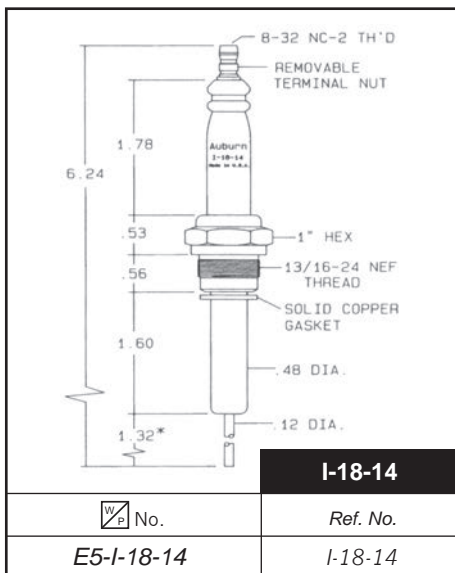
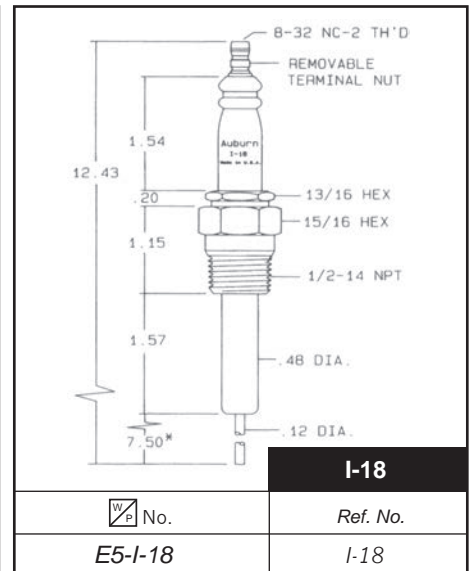
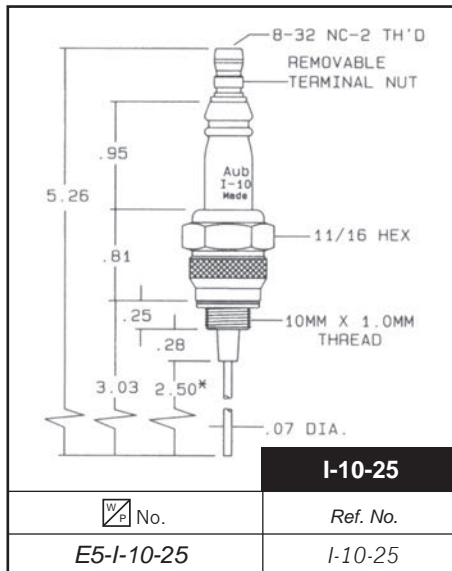
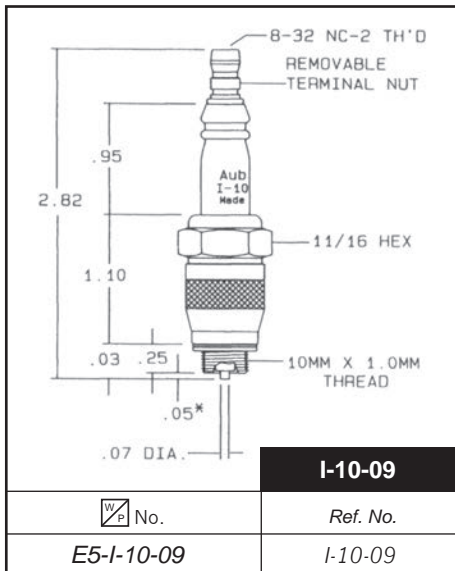
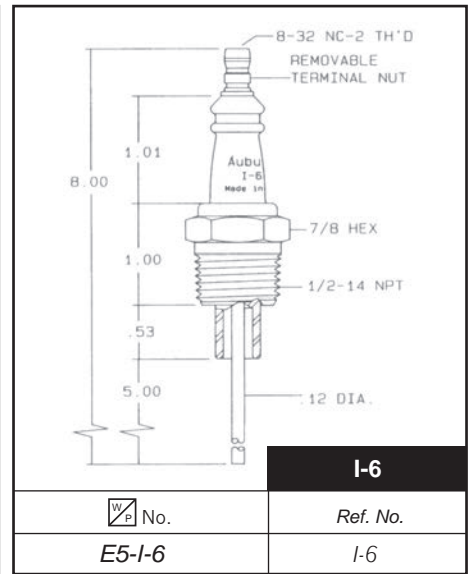
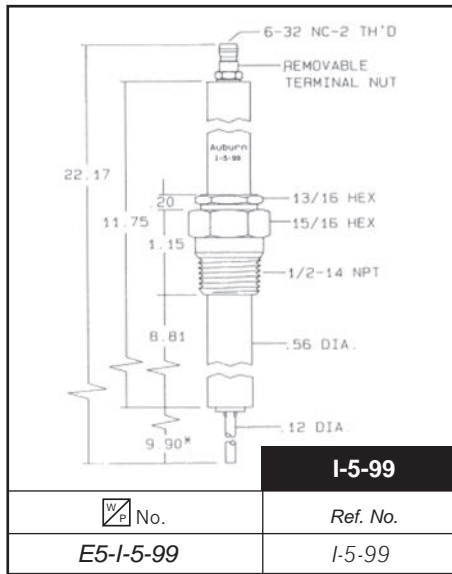
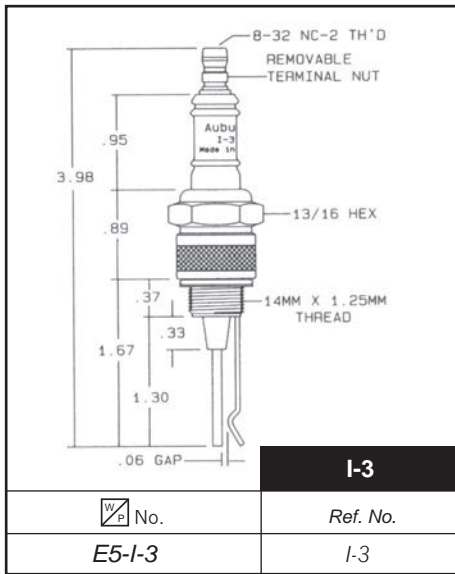

* Dimensions marked with an asterisk are standard lengths - Other lengths available upon request

Please order by No.

rev. 12-14-15

E16

AUBURN ELECTRODES

I-25-3

W/P No.	Ref. No.
E5-I-25-3	I-25-3

I-28

W/P No.	Ref. No.
E5-I-28	I-28

I-31 Series

W/P No.	Ref. No.	"A"	"B"	ELEC. MAT.
E5-I-31	I-31	3.68	1.37	NICKEL
E5-I-31-1	I-31-1	4.17	1.87	NICKEL
E5-I-31-2	I-31-2	4.81	2.50	NICKEL
E5-I-31-3	I-31-3	4.17	1.87	INCONEL
E5-I-31-5	I-31-5	6.43	4.12	NICKEL
E5-I-31-6	I-31-6	3.31	1.06	NICKEL

I-32 **E5-FI21501**

DISCONTINUED
SUBSTITUTE
FI21501

W/P No.	Ref. No.
E5-I-32 discontinued	I-32
E5-FI21501	FI21501

I-33

W/P No.	Ref. No.
E5-I-33	I-33

I-64 Series

¹UL Recognized

W/P No.	Ref. No.	"A"	"B"	GAP	ELEC. MAT.
E5-I-64-1	I-64-1	4.20	1.72	.090	NI
E5-I-64-3	I-64-3	6.24	3.75	.090	NI
E5-I-64-4 ¹	I-64-4	3.60	1.12	.100	NI

I-75-5

W/P No.	Ref. No.
E5-I-75-5	I-75-5

I-75-6

W/P No.	Ref. No.
E5-I-75-6	I-75-6

I-82

W/P No.	Ref. No.
E5-I-82	I-82

* Dimensions marked with an asterisk are standard lengths - Other lengths available upon request

AUBURN ELECTRODES

I-101	
No.	Ref. No.
E5-I-101	I-101

I-102	
No.	Ref. No.
E5-I-102	I-102

I-141	
No.	Ref. No.
E5-I-141	I-141

I-143	
No.	Ref. No.
E5-I-143	I-143

I-144	
No.	Ref. No.
E5-I-144	I-144

I-181	
No.	Ref. No.
E5-I-181	I-181

I-182	
No.	Ref. No.
E5-I-182	I-182

As a major distributor of Auburn Ignition Products, Westwood can special order any Auburn item not shown in this catalog and get it to you fast!

* Dimensions marked with an asterisk are standard lengths - Other lengths available upon request

AUBURN ELECTRODES

I-182-1	
No.	Ref. No.
E5-I-182-1	I-182-1

IA-9	
No.	Ref. No.
E5-IA-9	IA-9

IC-9-2	
No.	Ref. No.
E5-IC9-2	IC9-2

DISCONTINUED

IC-10	
No.	Ref. No.
E5-IC-10	IC-10

IC-15	
No.	Ref. No.
E5-IC-15	IC-15

DISCONTINUED

CHROMEL "D"
Center Wire

IC-15-3B	
No.	Ref. No.
E5-IC-15-3B	IC-15-3B

As a major distributor of Auburn Ignition Products, Westwood can special order any Auburn item not shown in this catalog and get it to you fast!

* Dimensions marked with an asterisk are standard lengths - Other lengths available upon request

AUBURN ELECTRODES

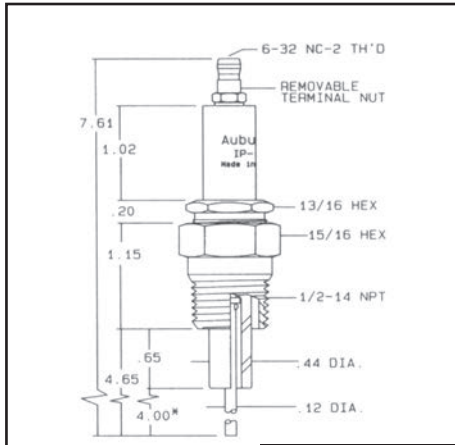

IP-9

No.	Ref. No.
E5-IP-9	IP-9

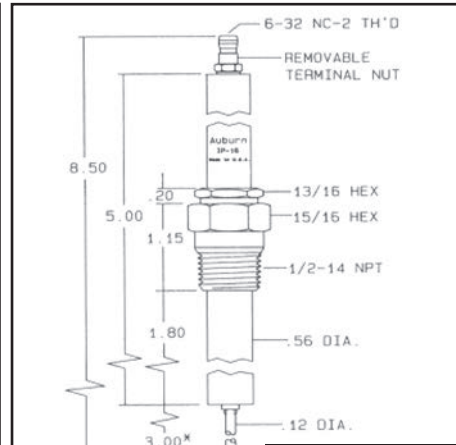

IP-16

No.	Ref. No.
E5-IP-16	IP-16

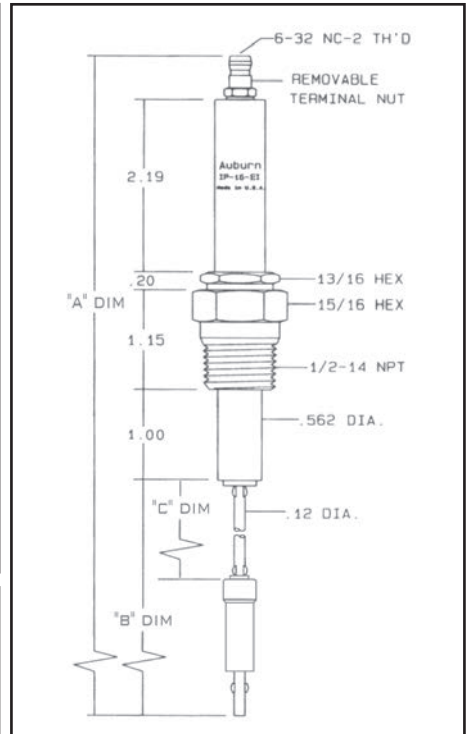

IP-16-EI Series

No.	Ref. No.	"A"	"B"	"C"
E5-IP-16-EI	IP-16-EI	18.75	13.25	11.25

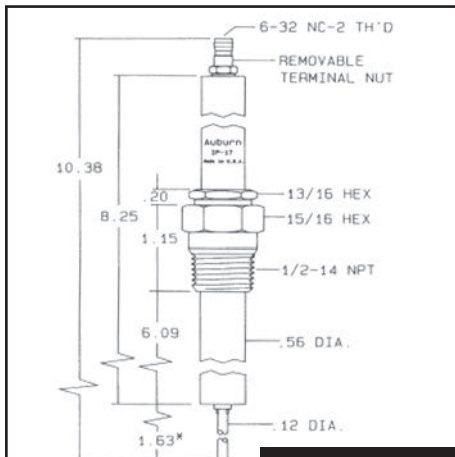

IP-17

No.	Ref. No.
E5-IP-17	IP-17

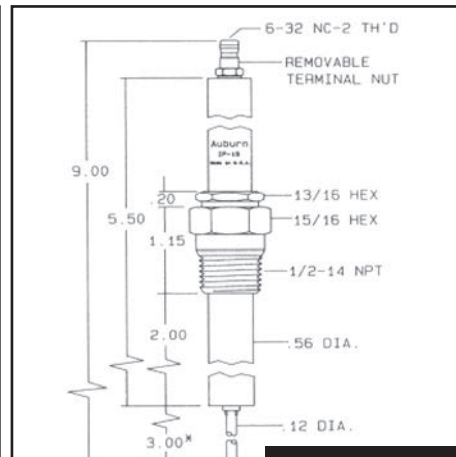

IP-19

No.	Ref. No.
E5-IP-19	IP-19

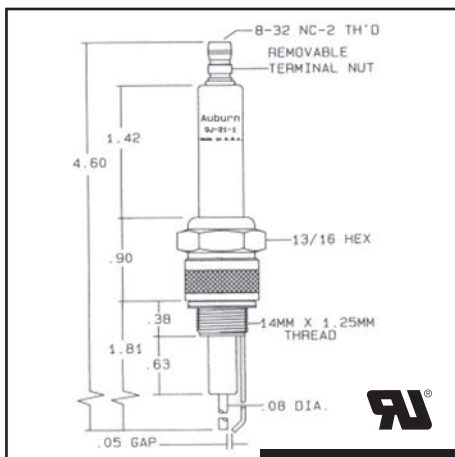

OJ-21-1

No.	Ref. No.
E5-OJ-21-1	OJ-21-1

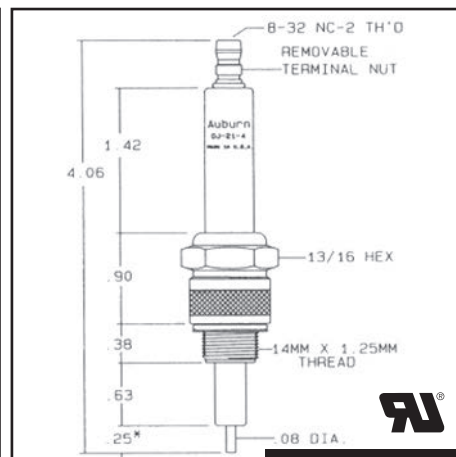

OJ-21-4

No.	Ref. No.
E5-OJ-21-4	OJ-21-4

As a major distributor of Auburn Ignition Products, Westwood can special order any Auburn item not shown in this catalog and get it to you fast!

* Dimensions marked with an asterisk are standard lengths - Other lengths available upon request

AUBURN ELECTRODES & FLAME RODS

OJ-21-5

W/P No.	Ref. No.
E5-OJ-21-5	OJ-21-5

FLAME ROD FRS-2 Series

Center electrode tip operating temp 2,350° F

W/P No.	Ref. No.	"A" DIM.
E5-FRS-2-6	FRS-2-6	6"
E5-FRS-2-12	FRS-2-12	12"
E5-FRS-2-18	FRS-2-18	18"
E5-FRS-2-24	FRS-2-24	24"

FLAME ROD FRS-4 Series

Center electrode tip operating temp 2,350° F

W/P No.	Ref. No.	"A" DIM.
E5-FRS-4-4	FRS-4-4	4"
E5-FRS-4-6	FRS-4-6	6"
E5-FRS-4-7-1/2	FRS-4-7-1/2	7-1/2"
E5-FRS-4-12	FRS-4-12	12"
E5-FRS-4-24	FRS-4-24	24"

FLAME ROD FRS-3

W/P No.	Ref. No.
E5-FRS-3	FRS-3

As a major distributor of Auburn Ignition Products, Westwood can special order any Auburn item not shown in this catalog and get it to you fast!

* Dimensions marked with an asterisk are standard lengths - Other lengths available upon request

AUBURN LIQUID LEVEL ELECTRODES

WCC Series:

Metal parts are 303 or 304 non-magnetic stainless steel. Incorporates an internal conductive glass seal (not recommended for use above 450 volts). Non-steam applications up to 2,500 PSI at 120° F or 0 PSI at 700° F. Steam applications up to 250 PSI at 406° F

WCC-KH Series:

Metal parts are 303 or 304 non-magnetic stainless steel. Incorporates a special insulator tip seal and Kovar center wire-glass seal. Non-steam applications up to 2,500 PSI at 120° F or 0 PSI at 450° F. Steam applications up to 450 PSI at 459° F

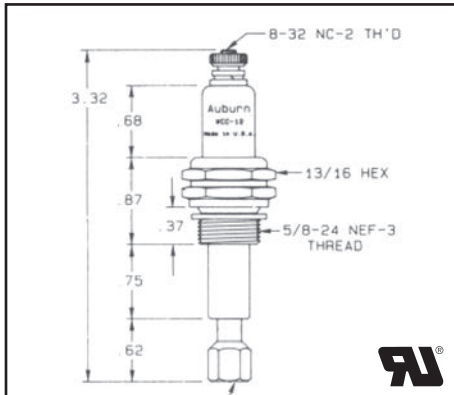

WCC-12

No.	Ref. No.
E5-WCC-12	WCC-12

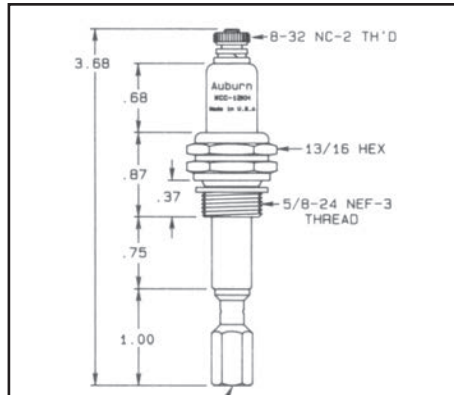

WCC-12KH

No.	Ref. No.
E5-WCC-12KH	WCC-12KH

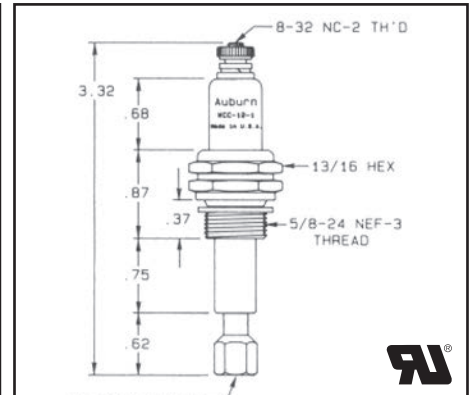

WCC-12-1

No.	Ref. No.
E5-WCC-12-1	WCC-12-1

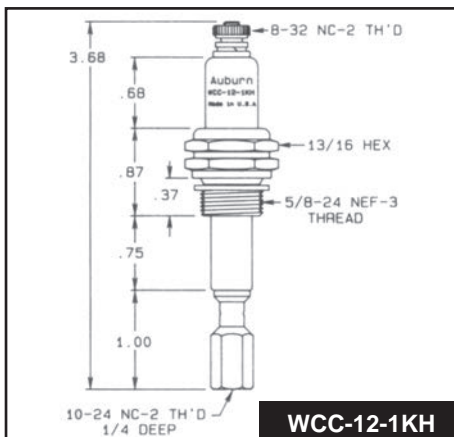

WCC-12-1KH

No.	Ref. No.
E5-WCC-12-1KH	WCC-12-1KH

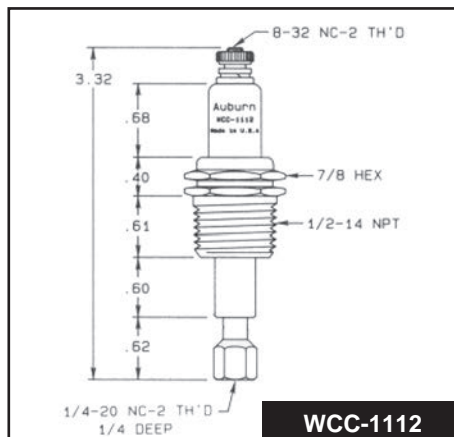

WCC-1112

No.	Ref. No.
E5-WCC-1112	WCC-1112

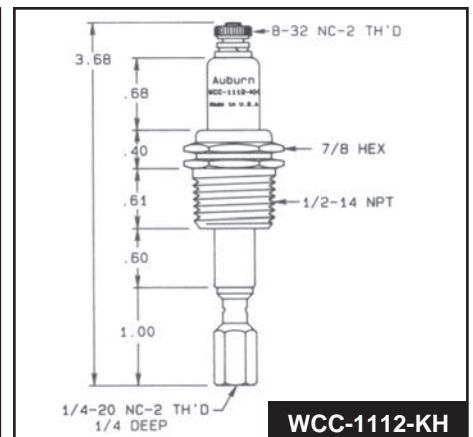

WCC-1112-KH

No.	Ref. No.
E5-WCC-1112-KH	WCC-1112-KH

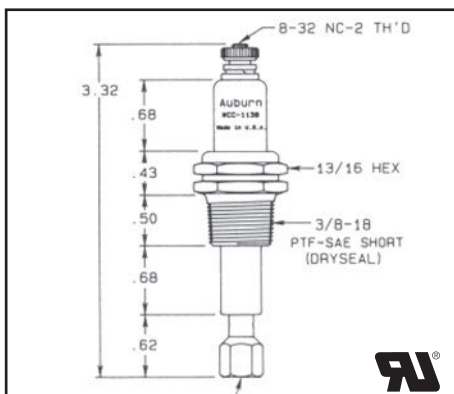

WCC-1138

No.	Ref. No.
E5-WCC-1138	WCC-1138

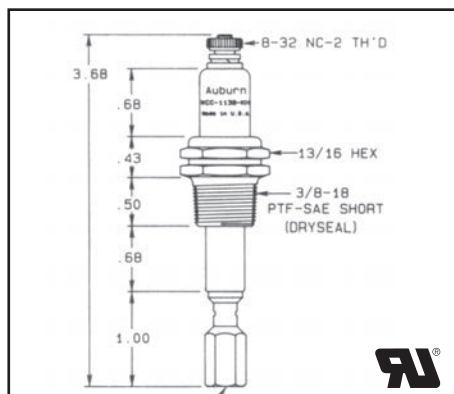

WCC-1138L

No.	Ref. No.
E5-WCC-1138L	WCC-1138L

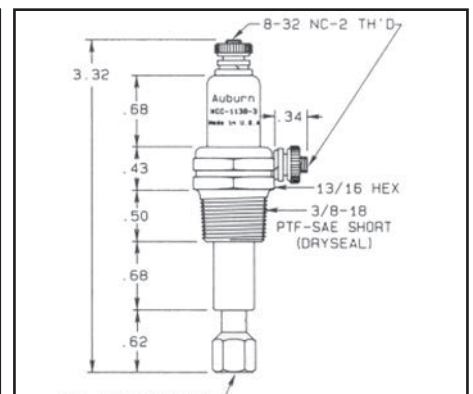

WCC-1138-3

No.	Ref. No.
E5-WCC-1138-3	WCC-1138-3

AUBURN LIQUID LEVEL ELECTRODES

WCT Series:

Metal parts are 303 or 304 non-magnetic stainless steel, center electrodes are one piece.

Non-steam applications up to 1,000 PSI at 120° F or 0 PSI at 400° F

Steam applications up to 100 PSI at 337° F

WCT-90	
No.	Ref. No.
E5-WCT-90	WCT-90

WCT-90-2	
No.	Ref. No.
E5-WCT-90-2	WCT-90-2

WCT-912	
No.	Ref. No.
E5-WCT-912	WCT-912

WCT-938	
No.	Ref. No.
E5-WCT-938	WCT-938

WCTL-3814	
No.	Ref. No.
E5-WCTL-3814	WCTL-3814

As a major distributor of Auburn Liquid Level Electrodes, Westwood can special order any Auburn item not shown in this catalog and get it to you fast!

No.	Ref. No.	Thread	Length	Dia.
E5-1024-12	1024-12	10-24	12"	3/16"
E5-1024-18	1024-18	10-24	18"	3/16"
E5-1024-24	1024-24	10-24	24"	3/16"
E5-1420-6	1420-6	1/4-20	6"	1/4"
E5-1420-12	1420-12	1/4-20	12"	1/4"
E5-1420-18	1420-18	1/4-20	18"	1/4"
E5-1420-24	1420-24	1/4-20	24"	1/4"
E5-1420-36	1420-36	1/4-20	36"	1/4"
E5-3816-12	3816-12	3/8-16	12"	3/8"
E5-3816-18	3816-18	3/8-16	18"	3/8"
E5-3816-24	3816-24	3/8-16	24"	3/8"

SOLID STAINLESS STEEL PROBES

FOR USE ON LIQUID LEVEL ELECTRODE ASSEMBLIES

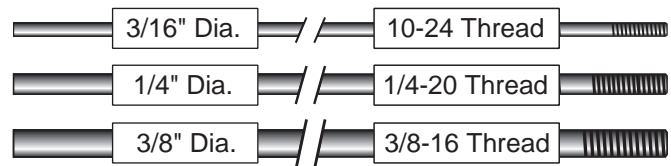

Take a look ...

LIQUID LEVEL PROBES for FULTON BOILERS on page H9

STANDARD SIZES*

*Made to order non-standard lengths available by special order.

Westwood

CHAMPION

IGNITION ASSEMBLIES



14 MM

CJ-8

No.

Ref. No.

E5-CJ-8

CJ-8

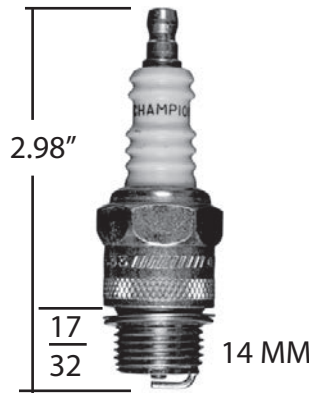

2.98"

$\frac{17}{32}$

14 MM

D-9

No.

Ref. No.

E5-D-9

D-9



3.22"

1"

18 MM
x 1.25MM

D-89D

No.

Ref. No.

E5-D-89D

D-89D



14 MM
x 1.25MM

H14Y

No.

Ref. No.

E5-H14Y

H14Y

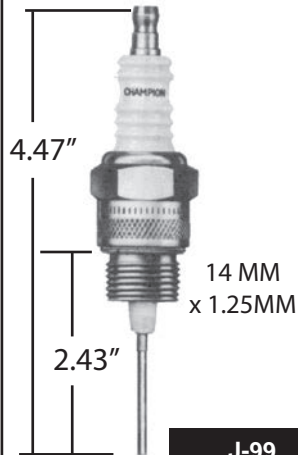

4.47"

2.43"

14 MM
x 1.25MM

J-99

No.

Ref. No.

E5-J-99

J-99



18 MM
x 1.25MM

K97F

No.

Ref. No.

E5-K97F

K97F

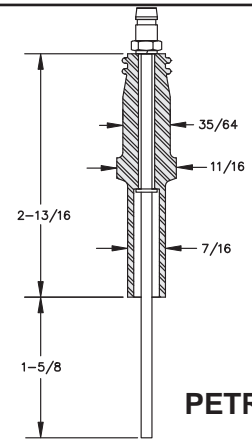

PETRO

OA-9

No.

Ref. No.

E5-OA-9

OA-9

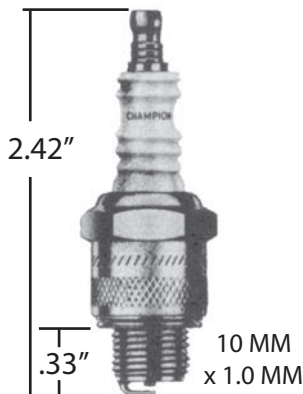

2.42"

.33"

10 MM
x 1.0MM

UY-6

No.

Ref. No.

E5-UY-6

UY-6



7/8-18
THD

W18

No.

Ref. No.

E5-W18

W18

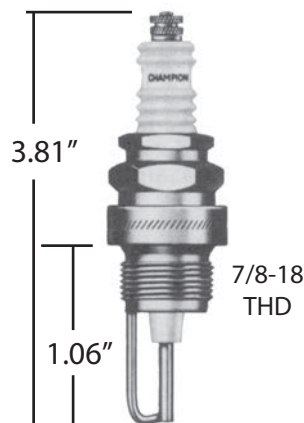

3.81"

1.06"

7/8-18
THD

W-95D

No.

Ref. No.

E5-W-95D

W-95D

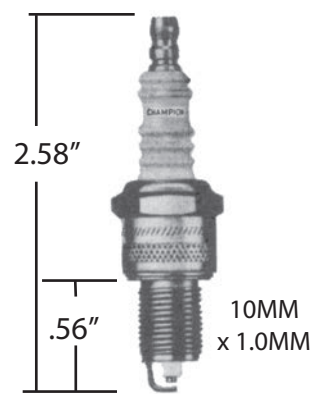

2.58"

.56"

10MM
x 1.0MM

Z-6

No.

Ref. No.

E5-Z-6

Z-6



TERMINALS



SPECIAL NOTE: NEW **Rajah**™ TERMINAL PART NUMBERS

Rajah™ terminals and related items part numbers are now "E9-" followed by the former part number.

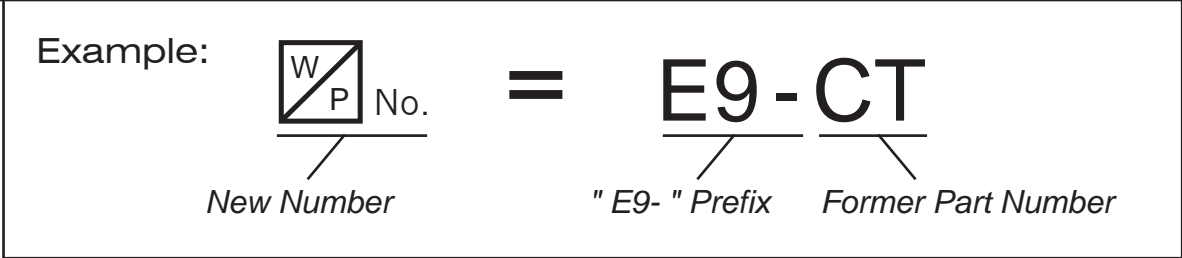

Note: Terminal part number endings of 6-32, 8-32, 10-24, and 10-32 refer to terminal thread size

 No. E9-CT	 No. E9-SS	 No. E9-R-2	 No. E9-SF	 No. E9-TT
 No. E9-CT-TS 8-32 E9-CT-TS 10-32	 No. E9-SS-TS 10-32	 No. E9-SR	 No. E9-HS 6-32 E9-HS 10-32	 No. E9-CT-BS 6-32 E9-CT-BS 8-32 E9-CT-BS 10-32
 No. E9-SS-BS 6-32 E9-SS-BS 8-32 E9-SS-BS 10-32	 No. E9-HT 6-32 E9-HT 8-32 E9-HT 10-32	 No. E9-SX-1 6-32 E9-SX-1 10-32	 No. E9-CT-SS	 No. E9-ACT
 No. E9-ASS	 No. E9-CHT	 No. E9-BS 6-32 E9-BS 8-32 E9-BS 10-24 E9-BS 10-32	 No. E9-458-9 10-32	 No. E9-RAC
 No. E9-RASS	 No. E9-EBS 6-32 E9-EBS 10-32	 No. E9-457-6 6-32	 No. E9-SS-SOS	 No. E9-R-SOS



TERMINALS



Note: Terminal part number endings of 6-32, 8-32, 10-24, and 10-32 refer to terminal thread size

 <p><input checked="" type="checkbox"/> No. E9-T-SOS</p>	 <p><input checked="" type="checkbox"/> No. E9-AS-SOS</p>	 <p><input checked="" type="checkbox"/> No. E9-BS-SOS</p>	 <p><input checked="" type="checkbox"/> No. E9-SSN</p>	 <p><input checked="" type="checkbox"/> No. E9-RSN</p>
 <p><input checked="" type="checkbox"/> No. E9-TSN</p>	 <p><input checked="" type="checkbox"/> No. E9-ASN</p>	 <p><input checked="" type="checkbox"/> No. E9-BSN</p>	 <p><input checked="" type="checkbox"/> No. E9-ACT-BS 6-32 E9-ACT-BS 10-32</p>	 <p><input checked="" type="checkbox"/> No. E9-DS-1</p>
 <p><input checked="" type="checkbox"/> No. E9-FF-1</p>	 <p><input checked="" type="checkbox"/> No. E9-CC-1</p>	 <p><input checked="" type="checkbox"/> No. E9-SS-LBS</p>	 <p><input checked="" type="checkbox"/> No. E9-SS-LTS</p>	 <p><input checked="" type="checkbox"/> No. E9-XC</p>
 <p><input checked="" type="checkbox"/> No. E9-SA-1 6-32</p>	 <p><input checked="" type="checkbox"/> No. E9-ITN 8-32 E9-ITN 10-32</p>	 <p><input checked="" type="checkbox"/> No. E9-ITN-S 6-32 E9-ITN-S 8-32</p>	 <p><input checked="" type="checkbox"/> No. E9-TC-10</p>	 <p><input checked="" type="checkbox"/> No. E9-TS-10</p>
 <p><input checked="" type="checkbox"/> No. E9-R-1</p>	 <p><input checked="" type="checkbox"/> No. E9-RS-3 10-32</p>	 <p><input checked="" type="checkbox"/> No. E9-RX-4 6-32 E9-RX-4 8-32 E9-RX-4 10-32</p>	 <p><input checked="" type="checkbox"/> No. E9-RX-5 10-32</p>	 <p><input checked="" type="checkbox"/> No. E9-RP-6</p>
 <p><input checked="" type="checkbox"/> No. E9-RC-5</p>	 <p><input checked="" type="checkbox"/> No. E9-RE-7</p>	 <p><input checked="" type="checkbox"/> No. E9-AEBF</p>	 <p><input checked="" type="checkbox"/> No. E9-EBF</p>	 <p><input checked="" type="checkbox"/> No. E9-B-10 10-32 5/16" Long</p>
 <p><input checked="" type="checkbox"/> No. E9-B-11 10-32 1 1/16" Long</p>	 <p><input checked="" type="checkbox"/> No. E9-BC-11</p>	 <p><input checked="" type="checkbox"/> No. E9-BS-12</p>		

Please order by No.



TERMINALS



Note: Terminal part number endings of 6-32, 8-32, 10-24, and 10-32 refer to terminal thread size

<p><i>Reckett</i> DISCONTINUED USE E9-Y5-10</p> <p>W/P No. E9-S-15 10-32</p>	<p>W/P No. E9-AL-10</p>	<p>W/P No. E9-AS-10</p>	<p>W/P No. E9-ASC</p>	<p>W/P No. E9-S-10</p>
<p>W/P No. E9-CS</p>	<p>W/P No. E9-YL-10</p>	<p>W/P No. E9-YS-10</p>	<p>W/P No. E9-YSC</p>	<p>1-1/8" Long</p> <p>W/P No. E9-SCS-2 6-32</p>
<p>1-1/4" Long</p> <p>W/P No. E9-SCS-1 10-32</p>	<p>W/P No. E9-KBN 6-32 E9-KBN 10-24</p>	<p>W/P No. E9-DT</p>	<p>W/P No. E9-CBS</p>	<p>Cleaver Brooks Spring Connects plate assembly to ignitors - 20" Long</p>

SPECIALTY TERMINAL & ELECTRODE HARDWARE

<p>1-1/2"</p> <p>Walter Kidde brass buss bar</p> <p>W/P No. E9-686 BAR</p>	<p>3/4" O.D. 9/16" I.D.</p> <p>7/16"</p> <p>Beveled and split brass bushing</p> <p>W/P No. E9-BB</p>	<p>1/2" O.D. 7/16" I.D.</p> <p>7/16"</p> <p>Zinc plated split steel bushing</p> <p>W/P No. E9-PB</p>	<p>9/16" O.D. 7/16" I.D.</p> <p>3/4"</p> <p>Zinc plated split steel bushing</p> <p>W/P No. E9-AB</p>	<p>5/8" O.D. 9/16" I.D.</p> <p>1"</p> <p>Zinc plated split steel bushing</p> <p>W/P No. E9-DB</p>
<p>3/4" O.D. - 9/16" I.D. 1/16" Thick</p> <p>Cleaver Brooks split ring zinc plated steel</p> <p>W/P No. E9-CBR</p>	<p>3/4" O.D. - 9/16" I.D. 1/16" Thick</p> <p>Copper gasket - dished</p> <p>W/P No. E9-467 GASKET</p>	<p>3/4" O.D. - 9/16" I.D. 1/32" Thick</p> <p>Copper gasket - flat</p> <p>W/P No. E9-I-18 GASKET</p>	<p>19/32" I.D. 3/4" O.D.</p> <p>1"</p> <p>Black bakelite shield for Ray</p> <p>W/P No. E9-500 SHIELD</p>	

BUSS BARS

W/P No.	Ref. No.	12" Length*
E9-TYPE ET	Type ET	Round brass with eyelet and 6-32 thread
E9-TYPE F	Type F	Flat brass with 1/8" hole
E9-TYPE ST	Type ST	Round brass with 6-32 thread

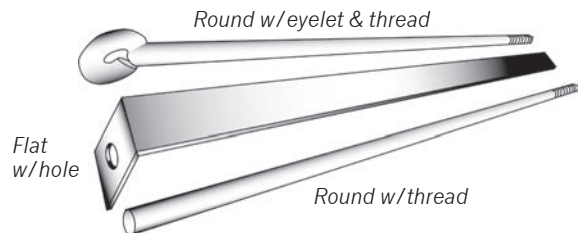

* Other lengths available up to 24"



IGNITION TERMINAL KITS

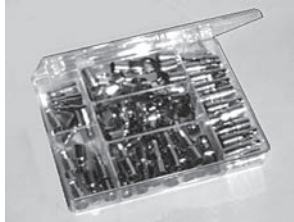

 No.	Ref. No.	Description
E9-34	34	Rajah™ "Mini" Ignition Terminal Kit:
		20 - CT Cage Terminals 12 - SS Spring Snap Terminals 20 - R2 Ring Terminals 10 - RAC Right Angle Cage Terminals 12 - SF Stud Ferrule Terminals
E9-54	54	Rajah™ Transformer Terminal Kit:
		6 - AS-10 Short Adapter Spring 6 - AL-10 Long Adapter Spring 2 - TC-10 Thumb Nut on Cage 2 - 458-9 Spring Plunger (10-32) 4 - B-10 Button Contact (short) 2 - B-11 Button Contact (long) 6 - CC-1 Cage on Cage 6 - RC-5 Ram's Horn on Cage 4 - RX4 Ram's Horn on Hex 2 - R1 Ram's Horn Clip 6 - HS Hollow Stud (10-32) 6 - SX-1 Hex Stud (10-32)
E9-2097	2097	Rajah™ "Pro" Ignition Terminal Kit:
		24 - CT Cage Terminals 24 - SS Spring Snap Terminals 24 - R2 Ring Terminals 24 - SF Stud Ferrule Terminals 24 - RAC Right Angle Cage Terminals 100 - DT Distributor Terminals 24 - FF-1 Ferrule on Ferrule 1 - T200-10 (former #695) Terminal Crimping Tool
E9-3500	3500	Rajah™ "Deluxe" Ignition Terminal Kit:
		12 - CT Cage Terminals 12 - SS Spring Snap Terminals 12 - R2 Ring Terminals 12 - ACT Angle Cage Terminals 12 - SF Stud Ferrule Terminals 12 - BS Base Stud (6-32) 12 - BS Base Stud (10-32) 12 - HS Hollow Stud (6-32) 12 - HS Hollow Stud (10-32) 12 - CC-1 Cage on Cage 12 - CT-TS Cage on Stud (10-32) 12 - RC-5 Ram's Horn on Cage 12 - R-1 Ram's Horn Clip 12 - #299 Special GE Slotted Stud 12 - SX-1 Hex Stud (10-32) 1 - 1/4" Nut Driver 1 - 5/16" Nut Driver 1 - T200-10 (former #695) Terminal Crimping Tool
E9-CK-1	CK-1	Rajah™ Carlin Transformer Contact Kit:
		For in the field conversion on Carlin Burner models 98, 99, 100, 101, 102 Webster transformer model 313-28AB85 2 - Contact clips 2 - Flat washers (#10) 2 - Shakeproof washers (#10) 2 - 10-32 nuts

Please order by  No.

ELECTRICAL CLIPS & RUBBER BOOTS

 <p><input checked="" type="checkbox"/> No. E9-LV CLIP</p>	<p><i>Vinyl</i></p>  <p><input checked="" type="checkbox"/> No. E9-LV BOOT</p>	 <p><input checked="" type="checkbox"/> No. E9-20 AMP CLIP</p>	<p><i>Vinyl</i></p>  <p><input checked="" type="checkbox"/> No. E9-20 AMP BOOT</p>
<p><i>Distributor nipple</i></p>  <p><input checked="" type="checkbox"/> No. E9-DN</p>	<p><i>Silicone Rubber</i></p>  <p><input checked="" type="checkbox"/> No. E9-250 BOOT</p>	<p><i>Silicone Rubber</i></p>  <p><input checked="" type="checkbox"/> No. E9-251 BOOT</p>	





Take a look ...

JUMPERS & CORD CLIP SETS on page T13

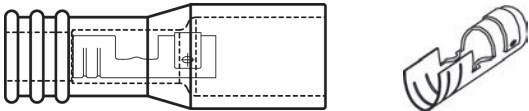
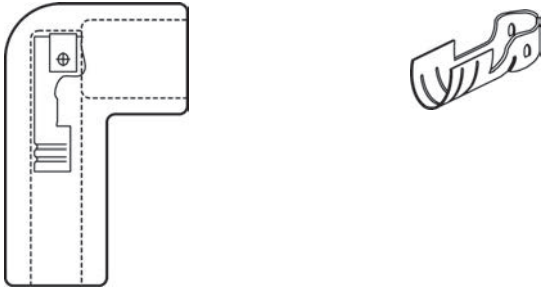
HIGH TEMPERATURE CERAMIC SPARK PLUG BOOTS with Stainless Steel Terminals

<input checked="" type="checkbox"/> No.	Ref. No.	Description
E9-ECF	ECF	<p><i>EXTENDED CERAMIC BOOT - with stainless steel terminal for 7mm ignition wire</i></p> 
E9-AECF	AECF	<p><i>ANGLE EXTENDED CERAMIC BOOT - with stainless steel terminal for 7mm ignition wire</i></p> 

Westwood IGNITION CABLE

Cable Type	 UL Recognized Component	 No.		
		25' Roll	100' Roll	1,000' Roll
GTO-15	Yes	E60-25	E60-100	E60-1000
White Silicone	-	E62-25	E62-100	-
Red Silicone	Yes	E63-25	E63-100	E63-1000

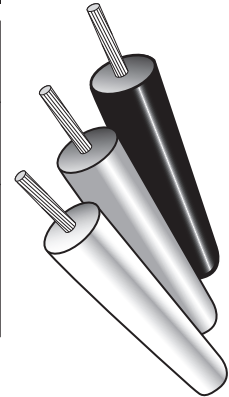

GTO-15 (black)	<p>Large .275" outside diameter fits Rajah terminals perfectly. Withstands more than 15,000 VAC with low current leakage. Resists arc-over, tracking, and burning. Tested to withstand conditions of heat, oil, and moisture. No. 14 gauge, 19 x 26 stranded tinned copper wire. All vinyl insulation affords low temperature flexibility. Flame retardant, will not support combustion. Tough and abrasion resistant, yet easy stripping. Temperature range: UL Recognized to 105° C (221° F)</p>
White Silicone	<p>Large .275" outside diameter fits Rajah terminals perfectly. Withstands more than 10,000 VAC and 25,000 VDC with low current leakage. No. 16 gauge, 19 x 26 stranded tinned copper wire. Natural Silicone insulation, high dielectric strength. Temperature range: -65° F to 400° F (-54° C to 204° C)</p>
Red Silicone	<p>Large .275" outside diameter fits Rajah terminals perfectly. Withstands more than 10,000 VAC and 25,000 VDC with low current leakage. No. 16 gauge, 19 x 26 stranded nickel plated copper wire. Natural Silicone insulation, high dielectric strength. Temperature range: -65° F to 482° F (-54° C to 250° C) UL Recognized</p>

CABLE ASSEMBLIES and FIBERGLAS BRAID

 No.	Ref. No.	Description
E64	#3250	Red Silicone wire high temperature cable assembly with protective metal braid . Temperature range -65° F to 450° F. Overall length is 32-1/2".
E64-5	#RS-3350	Red Silicone wire high temperature cable assembly with red Silicone boots . Temperature range -65° F to 450° F. Withstands 10,000 VAC / 25,000 VDC . Overall length is 33-1/2".
E64-20	#3253	Fiberglass braided sleeving. Fits over ignition cable for high temperature protection. Sold by the foot. (Ordering example: For 5' of sleeving order 5 of E64-20. Shipped as one piece)

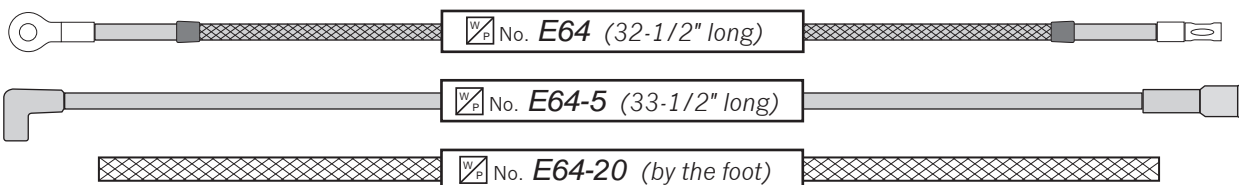

Please order by  No.

ELECTRICAL ACCESSORIES



SOLDERLESS TERMINAL KIT

No. **E70**

Contains 175 of the most popular terminals and connectors

KIT REFILL TERMINALS - Part numbers are for a package of the quantity indicated

 AWG: 22-16 Female .250 Tab No. E70-10	 AWG: 22-16 Ring #6 Stud No. E70-20	 AWG: 16-14 Ring #8 Stud No. E70-21	 AWG: 16-14 Spade #8 Stud No. E70-34	 AWG: 16-14 Spade #10 Stud No. E70-36	 AWG: 22-16 Butt Connector No. E70-40
BACK ROW - All Packages of 100					
 AWG: 16-14 Female .250 Tab No. E70-12	 AWG: 22-16 Ring #10 Stud No. E70-22	 AWG: 16-14 Ring #10 Stud No. E70-23	 AWG: 16-14 Spade #6 Stud No. E70-30	 AWG: 22-16 Spade #6 Stud No. E70-32	 AWG: 16-14 Butt Connector No. E70-42
MIDDLE ROW - Packages of 100					Pkg. of 50
 AWG: 12-10 Female .250 Tab No. E70-14	 AWG: 12-10 Ring #10 Stud No. E70-24	 AWG: 12-10 Ring 1/4" Stud No. E70-25	 AWG: 12-10 Ring 5/16" Stud No. E70-26	 AWG: 12-10 Spade #10 Stud No. E70-38	 AWG: 12-10 Butt Connector No. E70-44
FRONT ROW - All Packages of 50					

WIRE CONNECTORS - Part numbers are for a package of 100

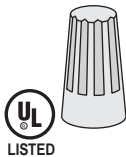

	<i>GREY</i>	<i>BLUE</i>	<i>ORANGE</i>	<i>YELLOW</i>	<i>RED</i>
No.	E70-50	E70-52	E70-54	E70-56	E70-58

CABLE TIES - Part numbers are for a package of 100

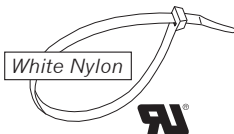

	4"	5-1/2"	7-1/2"	11"	14"
No.	E70-60	E70-62	E70-64	E70-66	E70-68

ROUGH SERVICE BULBS

Part numbers are for a box of 2 bulbs

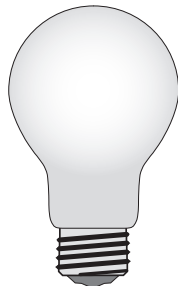

	75 Watt	100 Watt
No.	E70-75	E70-100



Westwood
CAD CELL FLAME DETECTORS

UNIVERSAL REPLACEMENT FOR HONEYWELL AND WHITE-RODGERS

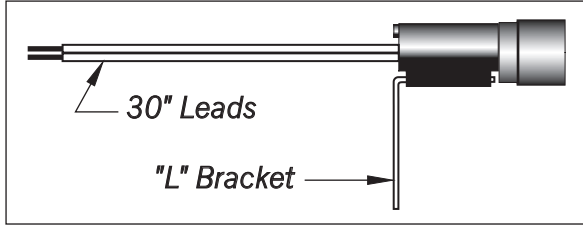
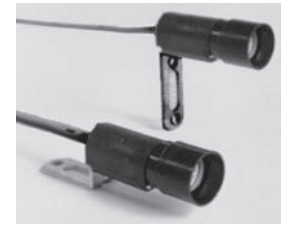

No. **E80**

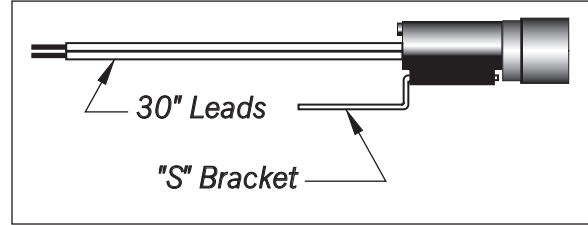

No. **E80-1**

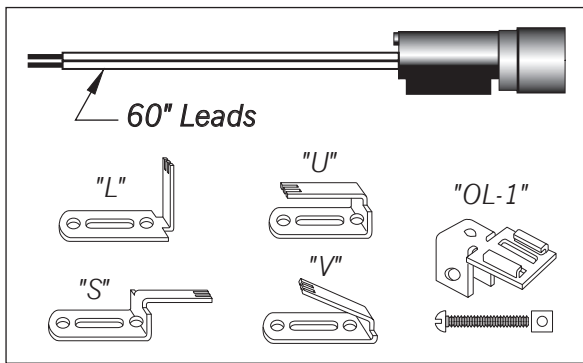

No. **E80-2**

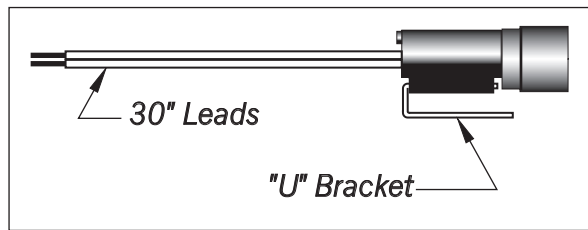

No. **E80-3**

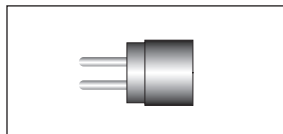

No. **E81**



No. **E81-10**

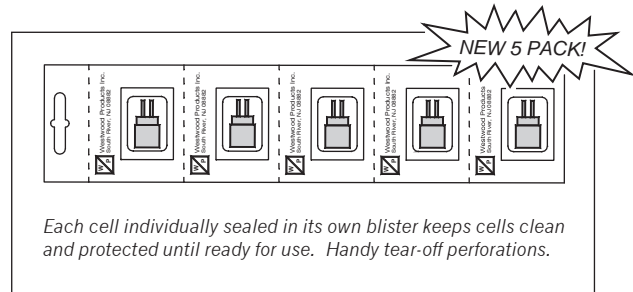

No. **E81-5**

No.	Ref. No.	Description
E80	TM-30L	Complete flame detector with cad cell eye*, 30" leads, "L" bracket, poly bag package
E80-1	TM-30S	Complete flame detector with cad cell eye*, 30" leads, "S" bracket, poly bag package
E80-2	TMK-60	Complete flame detector kit with cad cell eye*, 60" leads, "L" bracket, "S" bracket, "U" bracket, "V" bracket, "OL-1" special oil line bracket with mounting screw and nut, packaged in a box
E80-3	-	Complete flame detector with cad cell eye*, 30" leads, "U" bracket, poly bag package
E81	Type M	Cad cell eye* packaged in a box
E81-5	-	Cad cell eye* 5 pack (blister card with 5 E81-5 eyes per card), tear-off perforations
E81-10	Type W	Cad cell eye, bayonet mount for White-Rodgers cad cell flame detector DISCONTINUED

* Cad cell eye replaces Honeywell 130367 and fits C554A flame detector



T70 Cad cell relay and eye tester on page T11

Please order by No.

THERMOSTAT GUARDS

METAL AND PLASTIC TAMPER PROOF DESIGNS IN PLEASING COLORS

*Designed for use in schools, industrial plants and military installations where **rugged, maximum protection** is the first consideration. The louvered covers cannot be twisted or jammed open. Bobby pins, pencils, letter openers and other such objects cannot be inserted through the cover to adjust the thermostat.*

- ▶ Metal guards are constructed of 18-22 gauge steel with a baked enamel finish
- ▶ Plastic guards are molded from hi-impact plastic and can be used with both horizontally or vertically mounted thermostats
- ▶ All guards come with eight tumbler lock, one key, and mounting hardware
- ▶ Guards with ring bases can be installed without removing the thermostat



No. **E140**



No. **E140-1**

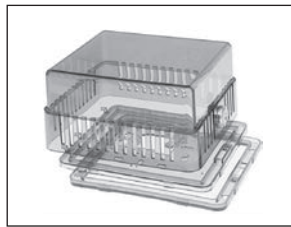

No. **E141**

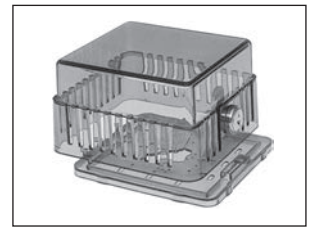

No. **E142**

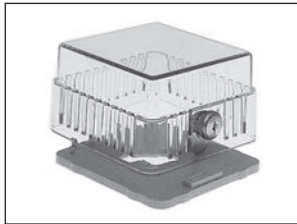

No. **E142-1**



No. **E142-2**

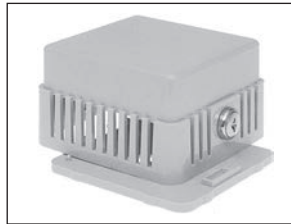

No. **E142-3**

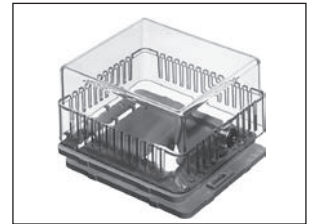

No. **E143**

No.	Ref. No.	Inside Dimensions H" x W" x D"	Mat'l	Color	Base	Comments
E140	WTG-54VL	6-1/4 x 4-3/4 x 3	M	BE	SH	T80, T90, T91, T199, T330, T340, T42, T26, T87, T92, T651, T921, T872, T882
E140-1	WTG-54VLW	6 x 3-13/16 x 3-1/8	M	BE	RH	
E141	WTG-B	5-1/4 x 4-5/8 x 3-1/4	P	BR	SR	T199, TP970, TP971, TP972, TP973, T26, T87, TS86, T832, T853, TP910
E142	WTG-EB	3-7/8 x 3-1/2 x 2-1/2	P	BR	S	
E142-1	WTG-EK	3-7/8 x 3-1/2 x 2-1/2	P	CL	S	
E142-2	WTG-EM	3-7/8 x 3-1/2 x 2-1/2	M	BE	S	
E142-3	WTG-EO	3-7/8 x 3-1/2 x 2-1/2	P	OP	S	
E143	WTG-K	5-1/4 x 4-5/8 x 3-1/4	P	CL	SR	

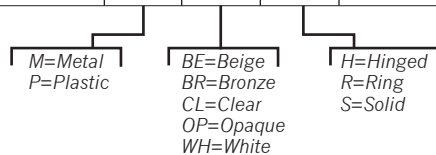

THERMOSTAT GUARDS (CONTINUED)

METAL AND PLASTIC TAMPER PROOF DESIGNS IN PLEASING COLORS

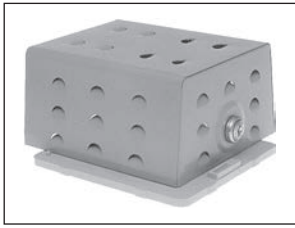

No. **E143-1**

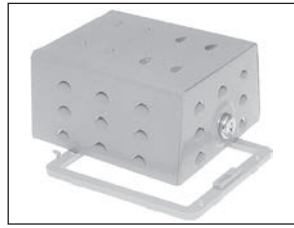

No. **E143-2**

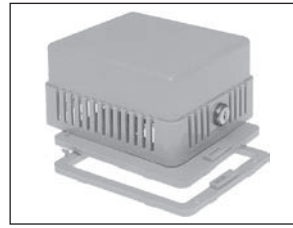

No. **E143-3**

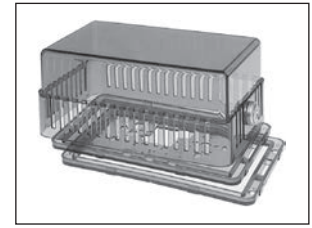

No. **E144**

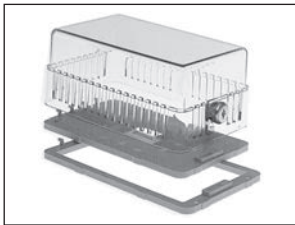

No. **E144-1**

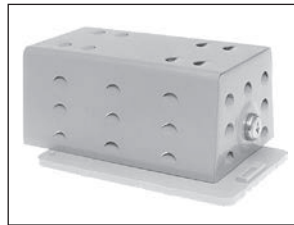

No. **E144-2**

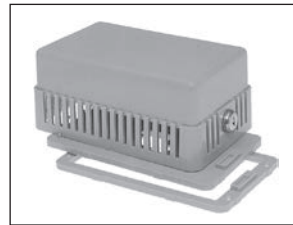

No. **E144-3**

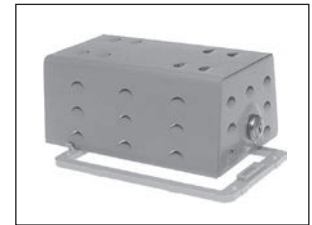

No. **E144-4**

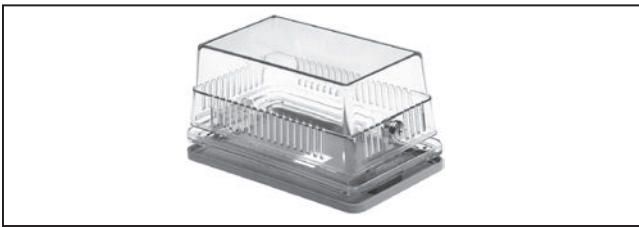

No. **E145 Series**

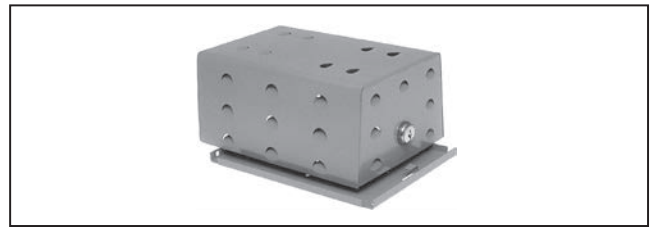

No. **E146**

No.	Ref. No.	Inside Dimensions H" x W" x D"	Mat'l	Color	Base	Comments
E143-1	WTG-KM	5-1/4 x 4-5/8 x 3	M	BE	S	
E143-2	WTG-KWM	5-1/4 x 4-5/8 x 3-1/4	M	BE	R	
E143-3	WTG-O	5-1/4 x 4-5/8 x 3-1/4	P	OP	SR	
E144	WTG-RB	6-3/8 x 3-1/2 x 3-1/4	P	BR	SR	
E144-1	WTG-RK	6-3/8 x 3-1/2 x 3-1/4	P	CL	SR	T80, T90, T91, T99, T199, T330, T340, T42, TA42, T26, TS86, T87, T92, T498, T651, T834, T921, T872, T882
E144-2	WTG-RM	6-3/8 x 3-1/2 x 3	M	BE	S	
E144-3	WTG-RO	6-3/8 x 3-1/2 x 3-1/4	P	OP	SR	
E144-4	WTG-RWM	6-3/8 x 3-1/2 x 3-1/4	M	BE	R	
E145	WTG-UB2	8-1/8 x 4-5/8 x 3-5/8	P	BR	SR	General, White-Rodgers, Barber Colman, Honeywell, Robertshaw, Camstat, Penn
E145-1	WTG-UK2	8-1/8 x 4-5/8 x 3-5/8	P	CL	SR	
E146	WTG-UM	7-1/4 x 5-3/8 x 3-1/2	M	BE	S	

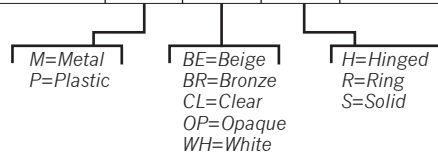

Please order by No.

THERMOSTAT GUARDS (CONTINUED)

METAL AND PLASTIC TAMPER PROOF DESIGNS IN PLEASING COLORS

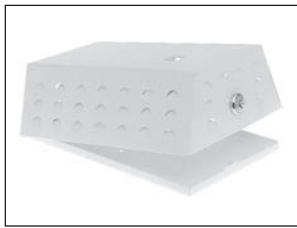

No. **E147 Series**

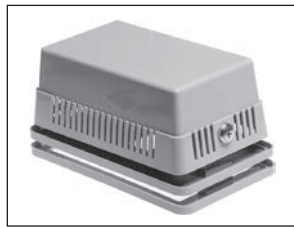

No. **E148**

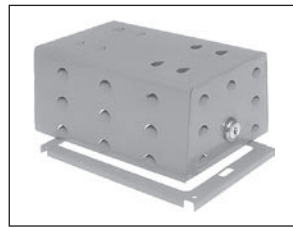

No. **E149**

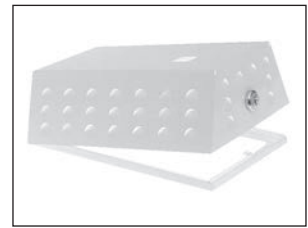

No. **E150 Series**

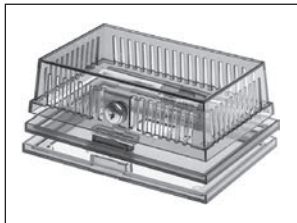

No. **E151**

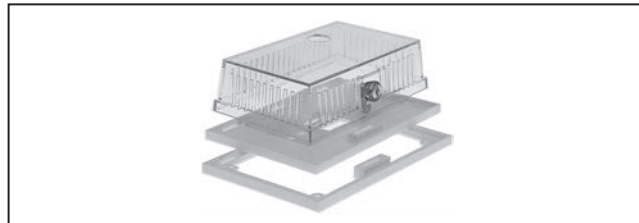

No. **E151-1, -2**



No. **E151-3**

No.	Ref. No.	Inside Dimensions H" x W" x D"	Mat'l	Color	Base	Comments
E147	WTG-UM1	9-3/8 x 6-3/4 x 3	M	WH	SH	Honeywell T7300 series
E147-1	WTG-UM1DH	9-3/8 x 6-3/4 x 3	M	WH	SH	Honeywell T7300 series w/display opening
E147-2	WTG-UM1DOH	9-3/8 x 6-3/4 x 3	M	WH	SH	Honeywell T7300 series w/override/display opening
E147-3	WTG-UM1DOWR	9-3/8 x 6-3/4 x 3	M	WH	SH	White-Rodgers IF90 series w/override/display opening
E147-4	WTG-UM1OH	9-3/8 x 6-3/4 x 3	M	WH	SH	Honeywell T7300 series w/override opening
E147-5	WTG-UM1SDH	9-3/8 x 6-3/4 x 3	M	WH	SH	Honeywell T7400 series w/display opening
E148	WTG-UO2	8-1/8 x 4-5/8 x 3-5/8	P	OP	SR	
E149	WTG-UWM	6-3/4 x 4-1/4 x 3-9/16	M	BE	R	
E150-1	WTG-UWM1DH	9-3/8 x 6-3/4 x 3	M	WH	RH	Honeywell T7300 series w/display opening
E150-2	WTG-UWM1DOH	9-3/8 x 6-3/4 x 3	M	WH	RH	Honeywell T7300 series w/override/display opening
E150-3	WTG-UWM1DOWR	9-3/8 x 6-3/4 x 3	M	WH	RH	White-Rodgers IF90 series w/override/display opening
E150-4	WTG-UWM1OH	9-3/8 x 6-3/4 x 3	M	WH	RH	Honeywell T7300 series w/override opening
E150-5	WTG-UWM1SDH	9-3/8 x 6-3/4 x 3	M	WH	RH	Honeywell T7400 series w/display opening
E151	WTG-DB	4-1/8 x 7-1/16 x 2-1/4	P	BR	SR	
E151-1	WTG-DK	4-1/8 x 7-1/16 x 2-1/4	P	CL	SR	
E151-2	WTG-DK1	4-1/8 x 7-1/16 x 2-1/4	P	CL	SR	w/override opening
E151-3	WTG-DO	4-1/8 x 7-1/16 x 2-1/4	P	OP	SR	

M=Metal
 P=Plastic
 BE=Beige
 BR=Bronze
 CL=Clear
 OP=Opaque
 WH=White
 H=Hinged
 R=Ring
 S=Solid

ULTRAGLO™ Thermostat Light

Mounts anywhere!

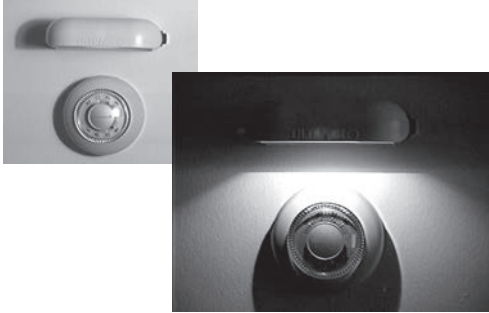

This easy to mount battery powered light has an ultra bright bulb that draws little current. It can be mounted in any convenient location with the two mounting screws provided. Easily slips out of its mounting bracket for use as a hand light. Use in cars, boats, RVs and campers too!

 No. **E140-40**

REPLACEMENT ZONE VALVE MOTOR

For motor driven OPEN, spring return CLOSE valves
(ie. Erie, Flare, Honeywell, Superior)

**INSTALLS WITHOUT REMOVING VALVE FROM PIPING
USING EASY TO INSTALL EXTENDED BRASS SCREWS**

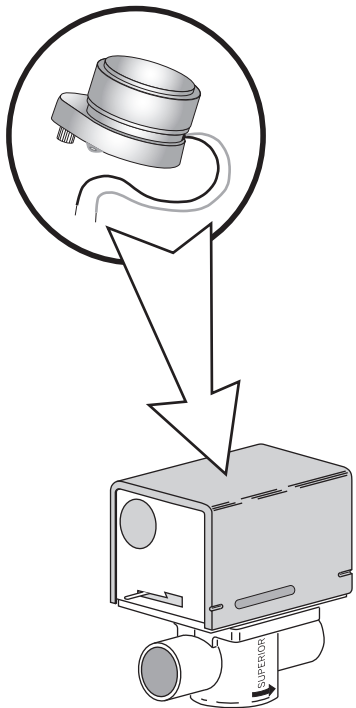

New easy to install screws!

 No.	Description
E180	Individually packaged with installation instructions, wire nuts, and easy to install extended brass mounting screws 24 VAC, 50/60 Hz, .32 A