

MAX-DRIVE

V-BELTS

OIL & HEAT RESISTANT

Rugged polyester cord and neoprene construction with specially treated natural and synthetic elastomeric compounds make the **MAX-DRIVE** V-belt the ideal choice for heavy loads under extreme heat or for constant exposure to oil.

When replacing a V-belt, always clean pulley grooves and check that shafts are parallel and pulley alignment is correct.

Standard V-Belt Types

	3L	4L	5L
W	3/8"	1/2"	21/32"

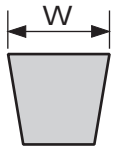

Outside Length (inches)	 No.		
	3L	4L	5L
20	S30-20	S40-20	-
21	S30-21	S40-21	-
22	S30-22	S40-22	-
23	S30-23	S40-23	S50-23
24	S30-24	S40-24	S50-24
25	S30-25	S40-25	S50-25
26	S30-26	S40-26	S50-26
27	S30-27	S40-27	S50-27
28	S30-28	S40-28	S50-28
29	S30-29	S40-29	S50-29
30	S30-30	S40-30	S50-30
31	S30-31	S40-31	S50-31
32	S30-32	S40-32	S50-32
33	S30-33	S40-33	S50-33
34	S30-34	S40-34	S50-34
35	S30-35	S40-35	S50-35
36	S30-36	S40-36	S50-36
37	S30-37	S40-37	S50-37
38	S30-38	S40-38	S50-38
39	S30-39	S40-39	S50-39

Outside Length (inches)	 No.		
	3L	4L	5L
40	S30-40	S40-40	S50-40
41	S30-41	S40-41	S50-41
42	S30-42	S40-42	S50-42
43	S30-43	S40-43	S50-43
44	S30-44	S40-44	S50-44
45	S30-45	S40-45	S50-45
46	S30-46	S40-46	S50-46
47	S30-47	S40-47	S50-47
48	S30-48	S40-48	S50-48
49	S30-49	S40-49	S50-49
50	S30-50	S40-50	S50-50
51	S30-51	S40-51	S50-51
52	S30-52	S40-52	S50-52
53	S30-53	S40-53	S50-53
54	S30-54	S40-54	S50-54
55	S30-55	S40-55	S50-55
56	S30-56	S40-56	S50-56
57	S30-57	S40-57	S50-57
58	S30-58	S40-58	S50-58
59	S30-59	S40-59	S50-59
60	S30-60	S40-60	S50-60



SPECIAL FOR LENNOX BURNER

 No.	Ref. No.	Lennox Burner No.	Belt Type	Outside Length
S20-16	VB-1049	DV-1049	2L - Cogged	16"

Westwood ceramic fibre chambers

SOUND ABSORBING • RED HOT IN SECONDS • FIRES DRY • 2,300° - 3,000°F

WET COMBUSTION CHAMBER LINERS - Sealed in a plastic bag and individually boxed*

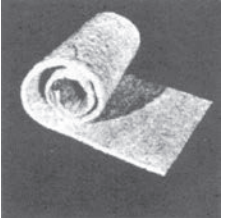

 No.	Ref. No.	Type		GPH	Description and Representative Picture	
S70-9 S70-10 S70-11 S70-12 S70-13 S70-15	#9 #10 #11 #12 #13 #15	Wet	Westwood Round - Preshaped	.50 - .75	9" diameter, 12" high	
				.85 - 1.00	10" diameter, 12" high	
				1.10 - 1.25	11" diameter, 12" high	
				1.35 - 1.50	12" diameter, 12" high	
				1.65 - 1.85	13" diameter, 14" high	
				2.00 - 2.50	15" diameter, 14" high	
S70-25 S70-27	#135 #200	Wet	Westwood Rect. - Preshaped	.75 - 1.35	14" x 11" x 12"	
				1.35 - 2.00	14" x 12" x 12"	
S70-30 S70-35 S70-40 S70-45	#1 #2 #3 #4	Wet	Westwood Flat sheet(s)	1.25	(1) - 14" x 48"	
				2.50	(1) - 14" x 48" (1) - 16" x 16"	
				2.65	(1) - 16" x 48" (1) - 16" x 16"	
				1.25	(1) - 16" x 48"	

*Wet chambers have a shelf life and should be ordered such that they are not held in inventory longer than 6 months.

J-M Cerafelt™

Dry Refractory Liners

DRY COMBUSTION CHAMBER LINERS

 No.	Ref. No.	Type		GPH	Description and Representative Picture	
S70-50 S70-51 S70-53	141608 141612 -	Dry	Cerafelt blanket	-	1/4" x 16" x 8 ft.	
				-	1/4" x 16" x 12 ft.	
				-	1/4" x 48" x 20 ft.	
S70-60	SS Kit	Dry	Cerafelt SS Kit (For lining burned out stainless steel combustion chambers)	.50 - 1.75	(1) - 14" x 48" (1) - 16" x 33" (8) - Stainless Steel Clips	

Westwood

HIGH TEMPERATURE ROPE

NON-ASBESTOS • KNITTED FIBERGLASS

This strong, flexible, resilient knit-braided rope is ideal for industrial boilers, cast iron boilers, wood burning stoves, ovens, and furnaces. Will not "bloom" or untwist like braided twisted glass rope. Made of 100% texturized fiberglass, it will not burn or support combustion. Resists temperatures to 1,000° F.

**NON-ASBESTOS HIGH TEMPERATURE ROPE**

 No.	Type	Description	Length
S70-101	Round	1/4" diameter	10 ft.
S70-102	Round	1/4" diameter	25 ft.
S70-104	Round	3/8" diameter	10 ft.
S70-106	Round	3/8" diameter	25 ft.
S70-108	Round	1/2" diameter	10 ft.
S70-110	Round	1/2" diameter	25 ft.
S70-111	Round	3/4" diameter	10 ft.
S70-112	Round	3/4" diameter	25 ft.
S70-114	Round	1" diameter	10 ft.
S70-116	Round	1" diameter	25 ft.
S70-140	Flat	1" wide x 1/8" thick	25 ft.
S70-142	Flat	1" wide x 1/8" thick with adhesive backing	100 ft.
S70-150	Flat	2" wide x 1/8" thick	25 ft.
S70-152	Flat	2" wide x 1/8" thick with adhesive backing	100 ft.

Other types and sizes of high temperature materials are available on special order. Consult the factory for price and availability.

BECKETT BURNER FLANGE GASKET

 No.	Description
S70-170	Gasket for Beckett and Aero burner flange 8-1/2" OD x 3-5/16" ID

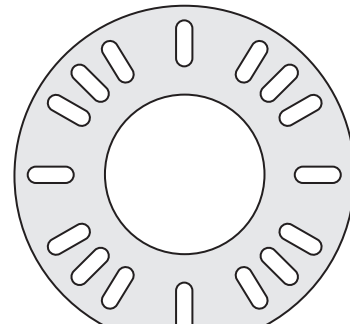

Westwood ONE PIECE MOTOR COUPLINGS

HEAVY DUTY FOR GENERAL USE ON BURNERS AND MOTOR DRIVEN EQUIPMENT



Rugged, precision machined end pieces are held in place by heavy steel collars. Set screws at each end insure that there is no slippage on the shaft flats. Quiet, noise and vibration absorbing, these premium couplings out-perform conventional couplings where misalignment exists or where punishing service is the norm. Available for 1/2" x 7/16" and 1/2" x 5/16" shaft sizes, or 7/16" shaft x spline socket.

ONE PIECE COUPLINGS

Length	No.		
	1/2" x 7/16"	1/2" x 5/16"	7/16" x Spline
2"	S80-200*	S81-200*	-
2-3/8"	S80-237	S81-237*	-
2-1/2"	S80-250*	S81-250*	-
3"	S80-300*	S81-300*	S82-300*
3-1/4"	S80-325	S81-325*	S82-325
3-3/8"	S80-337	S81-337*	S82-337
3-1/2"	S80-350*	S81-350	S82-350
4"	S80-400*	S81-400	S82-400*
4-1/2"	S80-450*	S81-450	S82-450
5"	S80-500	S81-500	S82-500*
5-1/2"	S80-550	S81-550	S82-550
6"	S80-600	S81-600	S82-600
6-1/2"	S80-650	S81-650	S82-650
7"	S80-700	S81-700	S82-700
7-1/2"	S80-750	S81-750	S82-750
8"	S80-800	S81-800	S82-800

* Included in One Piece Coupling Kit No. S83-200, shown below

REDUCER BUSHING & COUPLING KIT

No.	Ref. No.	Description
S83-10	Reducer Bushing	5/16" I.D. x 7/16" O.D. bushing
S83-200	1890	One piece coupling kit containing those couplings marked with an asterisk above, plus (6) S83-10 reducer bushings

Westwood
Nylo-Flex™ BURNER COUPLINGS

EASILY INSTALLED 3 PIECE COUPLING • NO SET SCREWS



Cut

Assemble

Chosen by top service professionals and original equipment (oem) burner manufacturers. Three piece design allows for custom fit in all installations.

Nylo-Flex™ COMPONENTS

 No.	Reference No.	Description and Representative Picture
S85-6	6" Nyloshaft	Nylo-Flex™ 6" Nyloshaft center piece
S85-10	10" Nyloshaft	Nylo-Flex™ 10" Nyloshaft center piece
S85-12	12" Nyloshaft	Nylo-Flex™ 12" Nyloshaft center piece
S85-15	15" Nyloshaft	Nylo-Flex™ 15" Nyloshaft center piece
S85-30	30" Nyloshaft	Nylo-Flex™ 30" Nyloshaft center piece
S85-100	Red End Fitting	Nylo-Flex™ 5/16" shaft size end piece, RED
S85-110	Blue End Fitting	Nylo-Flex™ 7/16" shaft size end piece, BLUE
S85-120	Black End Fitting	Nylo-Flex™ 1/2" shaft size end piece, BLACK
S85-130	TA	Nylo-Flex™ Torrington adapter, 1/2" shaft

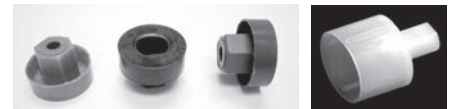

Nylo-Flex™ OEM SPEC COUPLINGS*

Two end pieces, plus a Nyloshaft correctly cut to OEM specs

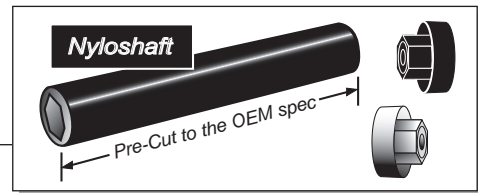

 No.	Description
S85-200	Nylo-Flex™ Pre-cut Coupling for Beckett AF (2454), 1/2" & 5/16" Ends, 3-13/32" Nyloshaft
S85-210	Nylo-Flex™ Pre-cut Coupling for Beckett (2290), 1/2" & 7/16" Ends, 2-7/8" Nyloshaft
S85-220	Nylo-Flex™ Pre-cut Coupling for Carlin 99-100 (99RA10208), 1/2" & 5/16" Ends, 2-3/16" Nyloshaft
S85-222	Nylo-Flex™ Pre-cut Coupling for Carlin (99RA5220), 1/2" & 7/16" Ends, 3-1/16" Nyloshaft
S85-223	Nylo-Flex™ Pre-cut Coupling for Carlin CRDA (1020J), 1/2" & 7/16" Ends, 2-3/4" Nyloshaft
S85-224	Nylo-Flex™ Pre-cut Coupling for Carlin 1020 (A Pump), 1/2" & 5/16" Ends, 2-11/32" Nyloshaft
S85-225	Nylo-Flex™ Pre-cut Coupling for Ducane (B1011503), 1/2" & 5/16" Ends, 3-13/16" Nyloshaft
S85-227	Nylo-Flex™ Pre-cut Coupling for Lennox (65A4101), 1/2" & 5/16" Ends, 3-5/8" Nyloshaft
S85-229	Nylo-Flex™ Pre-cut Coupling for Wayne E (13279), 1/2" & 5/16" Ends, 4-5/16" Nyloshaft
S85-230	Nylo-Flex™ Pre-cut Coupling for Wayne (13424), 1/2" & 5/16" Ends, 3-13/16" Nyloshaft
S85-231	Nylo-Flex™ Pre-cut Coupling for Wayne M, 1/2" & 5/16" Ends, 3-1/4" Nyloshaft

* Each coupling individually sealed in a plastic bag and labeled



Nylo-Flex™ COUPLING KITS on page S6

Please order by  No.

Westwood

Nylo-Flex™ BURNER COUPLINGS

THE WIDEST SELECTION TO MEET ALL SERVICING NEEDS

COUPLING KITS



No. S85-500



No. S85-525



No. S85-510



No. S85-550



No. S85-560

Nylo-Flex™ COUPLING KITS

No.	Ref. No.	Quantity of End Pieces			Nyloshaft Quantity & Length	S85-130 Torrington Adapter	T100-300 Coupler Popper™	T100-310 Coupling Cutter	Molded Plastic Box
		1/2"	7/16"	5/16"					
S85-500	#88	1	1	1	1 - 6"	-	-	-	-
S85-502	-	1	1	1	1 - 12"	-	-	-	-
S85-510	#99A	2	2	1	1 - 6"	-	-	-	-
S85-520	#101	2	1	2	1 - 6"	-	-	-	-
S85-525	-	8	6	5	6 - 6"	-	-	-	-
S85-530	#1240	16	8	8	8 - 9"	-	-	-	YES
S85-540	#1240C	16	8	8	8 - 9"	-	-	-	-
S85-550	#1242	16	8	8	8 - 9"	-	YES	YES	YES
S85-560	#1250	12	12	5	12 - 6"	5	-	-	-
S85-570	#1251	12	12	5	12 - 6"	5	YES	-	-

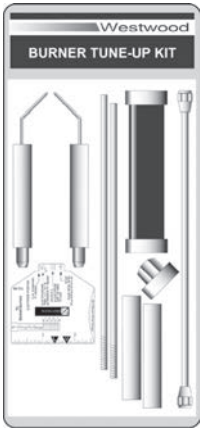

No. S88-14

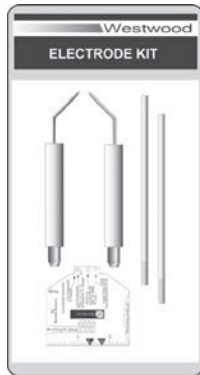

No. S88-20

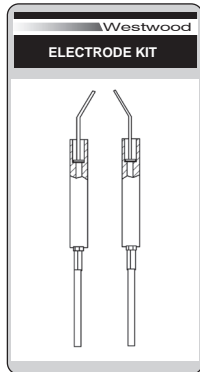

No. S88-36

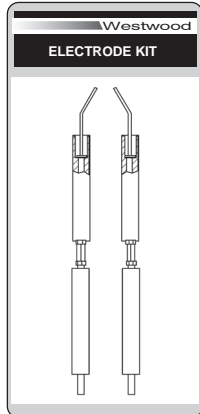

No. S88-38

Westwood BURNER TUNE-UP KITS

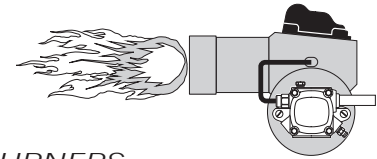

A REAL TIME SAVER FOR THE MOST POPULAR BURNERS

TUNE-UP & ELECTRODE KITS

No.	Ref. No.	Description
S88-10	BK5780	TUNE-UP KIT for Beckett AF, AFG, AR, SF, SR (up to 9" air tube) 2 - Electrode assemblies 1 - 12" oil line assembly 1 - Pump coupling kit S85-500 2 - Extension rods with nuts 1 - TG-99 tip setting gauge 2 - Hex connectors
S88-12	NBK5780	TUNE-UP KIT for Beckett AF, AFG, AR, SF, SR (up to 9" air tube) 2 - Electrode assemblies 1 - 12" oil line assembly 1 - Pump coupling kit S85-500 2 - Extension rods with nuts 1 - TG-99 tip setting gauge 1 - NAS gauge™ B-1 nozzle gauge 2 - Hex connectors
S88-14	BK5782	TUNE-UP KIT for Beckett AF, AFG, AR, SF, SR (over 9" air tube) 2 - Electrode assemblies 1 - 12" oil line assembly 2 - E5-2M4 insulators 1 - Pump coupling kit S85-500 2 - Extension rods with nuts 1 - TG-99 tip setting gauge 2 - Hex connectors
S88-16	NBK5782	TUNE-UP KIT for Beckett AF, AFG, AR, SF, SR (over 9" air tube) 2 - Electrode assemblies 1 - 12" oil line assembly 2 - E5-2M4 insulators 1 - Pump coupling kit S85-500 2 - Extension rods with nuts 1 - TG-99 tip setting gauge 1 - NAS gauge™ B-1 nozzle gauge 2 - Hex connectors
S88-20	W5780	ELECTRODE KIT for Beckett AF, AFG, SF, SR (up to 9" air tube) 2 - Electrode assemblies 2 - Extension rods with nuts 2 - Hex Connectors 1 - TG-99 tip setting gauge
S88-22	W5781	ELECTRODE KIT for Beckett A and S (up to 9" air tube) 2 - Electrode assemblies 2 - Extension rods with nuts 2 - Hex Connectors
S88-24	W5782	ELECTRODE KIT for Beckett AF, AFG, SF, SR (over 9" air tube) 2 - Electrode assemblies 2 - Extension rods with nuts 2 - Insulators 2 - Hex Connectors 1 - TG-99 tip setting gauge
S88-26	W5783	ELECTRODE KIT for Beckett AQ and S (over 9" air tube) 2 - Electrode assemblies 2 - Extension rods with nuts 2 - Insulators 2 - Hex Connectors
S88-28	W5940	ELECTRODE KIT for Beckett MB and MD (up to 9" air tube) 2 - Electrode assemblies 2 - Extension rods with nuts 2 - Hex Connectors 1 - TG-99 tip setting gauge
S88-32	51484U	ELECTRODE KIT for Beckett AF II, HLX (up to 9" air tube) 2 - Electrode assemblies 2 - Extension rods with nuts 2 - Hex Connectors 1 - TG-99 tip setting gauge
S88-34	51670U	ELECTRODE KIT for Beckett AF II, FBX (up to 9" air tube) 2 - Electrode assemblies 2 - Extension rods with nuts 2 - Hex Connectors 1 - TG-99 tip setting gauge
S88-36	BK-1	ELECTRODE KIT for Beckett AF, AFG, AR, SF, SR (up to 9" air tube) 2 - Beckett 1510 electrodes 2 - 3/16" x 6" buss bar rods 2 - 10-32 nuts 2 - Hex Connectors
S88-38	BK-2	ELECTRODE KIT for Beckett AF, AFG, AR, SF, SR (all size air tube) 2 - Beckett 1510 electrodes 2 - 3/16" x 13" buss bar rods 2 - E5-2M4 insulators 2 - 10-32 nuts 2 - Hex Connectors
S88-40		ELECTRODE KIT for Beckett CF500, CF800, up to 9" 2 - Electrode assemblies 1 - Instruction sheet

Packaging may vary from that shown

Please order by No.

Westwood

BURNER TUNE-UP KITS

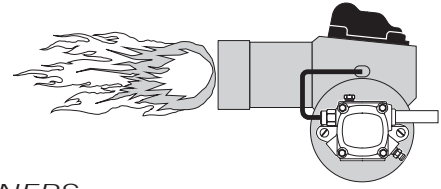

A REAL TIME SAVER FOR THE MOST POPULAR BURNERS
TUNE-UP & ELECTRODE KITS (Continued)

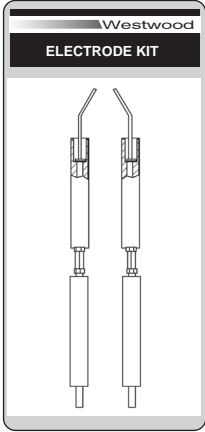

W/P No. **S88-38**



W/P No. **S88-74**



W/P No. **S88-78**

W/P No. **S88-80**

W/P No.	Ref. No.	Description
S88-42		ELECTRODE KIT for Beckett CF500, CF800, over 9"
		2 - Electrode assemblies 1 - Instruction sheet
S88-44		ELECTRODE KIT for Beckett CF1400, CF3500
		2 - Electrode assemblies
S88-46		ELECTRODE KIT for Beckett NX
		2 - Electrode assemblies 2 - Couplings
		2 - Rod extensions 4-7/8" long 1 - Instructions 2 - Rod extensions 2-7/8" long
S88-48		ELECTRODE KIT for Beckett CF375
		2 - Electrode assemblies 1 - Instructions 2 - Support insulators
S88-50		TUNE-UP KIT for Carlin 98 - 102, Elite, 201CRD, 301CRD
		2 - Electrode assemblies 1 - Yellow tip setting gauge 1 - 12" oil line assembly 1 - Pump coupling kit S85-500 1 - Red tip setting gauge 1 - Instructions
S88-60	WMK-100	TUNE-UP KIT for Weil McLain burner
		1 - One piece electrode assembly 1 - Coupling 2 - Ignition cable leads 1 - Oil line assembly
S88-70	31156	TUNE-UP KIT for Wayne ER, ERA, EH, EHA, EHASR, M, MSR, MH, OE, OEA
		2 - Electrode stems 1 - Oil line assembly 2 - Electrode assemblies w/insul. 1 - Coupling 2 - Insulator bushings 1 - "J" pump coupling end 2 - Buss bars (8") 1 - 90° nozzle line flare elbow 1 - Buss bar support
S88-72	31156W	TUNE-UP KIT for Wayne ER, ERA, EH, EHA, EHASR, M, MSR, MH, OE, OEA Same components as S88-70, manufactured by Westwood
S88-74	31157	TUNE-UP KIT for Wayne Blue Angel model HS
		2 - Electrode assemblies w/buss bars 1 - Coupling 1 - Electrode support 1 - "J" pump coupling end 1 - Buss bar support 1 - 90° nozzle line flare elbow 1 - Oil line assembly 1 - Gun setting gauge
S88-76	31157W	TUNE-UP KIT for Wayne Blue Angel model HS Same components as S88-74, manufactured by Westwood
S88-78		TUNE-UP KIT for Wayne Blue Angel Plus model HS, up to 6"
		1 - Electrode assemblies w/buss bars 1 - Coupling 1 - Buss bar support 1 - 90° nozzle line flare elbow 1 - Oil line assembly 1 - Gun setting gauge
S88-80		TUNE-UP KIT for Wayne Blue Angel Plus model HS, over 6"
		1 - Electrode assemblies w/buss bars 1 - Coupling 1 - Buss bar support 1 - 90° nozzle line flare elbow 1 - Oil line assembly 1 - Gun setting gauge

S8

Packaging may vary from that shown

rev. 11-29-17

Please order by **W/P** No.



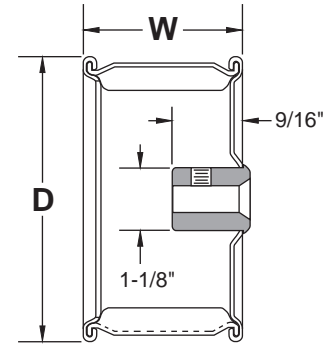

Westwood
BLOWER WHEELS

Precision balanced general purpose blower wheel ideal for oil burners. Blade strip is continuous and roll-locked front and back.





BLOWER WHEELS (Rotation as viewed from closed end)

CW		CCW		D	W	Fits shaft size	Comments
 No.	Ref. No.	 No.	Ref. No.				
STANDARD							
S90-10	4030	-	-	4"	3"	1/2"	
S90-12	4230	-	-	4-1/4"	3"	1/2"	
S90-14	4235	-	-	4-1/4"	3-1/2"	1/2"	
S90-16	4725	-	-	4-3/4"	2-1/2"	1/2"	
S90-18	4729	S91-18	4729-1	4-3/4"	3"	1/2"	
S90-20	4734	S91-20	4734-1	4-3/4"	3-1/2"	1/2"	
S90-22	5220	S91-22	5220-1	5-1/4"	2"	1/2"	
S90-24	5225	S91-24	5225-1	5-1/4"	2-1/2"	1/2"	
S90-26	5229	S91-26	5229-1	5-1/4"	3"	1/2"	
S90-28	5234	S91-28	5234-1	5-1/4"	3-1/2"	1/2"	
S90-30	5729	S91-30	5729-1	5-3/4"	3"	1/2"	
S90-32	5734	S91-32	5734-1	5-3/4"	3-1/2"	1/2"	
S90-34	5738	S91-34	5738-1	5-3/4"	3-7/8"	1/2"	
S90-36	6325	-	-	6-1/4"	2-1/2"	1/2"	
S90-38	6329	S91-38	6329-1	6-1/4"	3"	1/2"	
S90-40	6334	S91-40	6334-1	6-5/16"	3-1/2"	1/2"	
S90-42	6338	S91-42	6338-1	6-1/4"	3-7/8"	1/2"	
S90-44	6342	S91-44	6342-1	6-1/4"	4-1/4"	1/2"	
S90-46	6346	-	-	6-1/4"	4-5/8"	1/2"	
-	-	S91-48	7243-1	7"	4-1/4"	1/2"	
SPECIAL							
S90-60	475-243	-	-	4-3/4"	2-7/16"	1/2"	Outside hub
S90-62	475-287	-	-	5-3/4"	2-7/8"	1/2"	Lovejoy prongs
S90-64	575-287	-	-	5-3/4"	2-7/8"	1/2"	Lovejoy prongs
S90-66	625-400	-	-	6-1/4"	4"	1"	Cast hub
S90-68	951-78	-	-	7"	4-1/4"	5/8"	
S90-70	951-81	-	-	9-3/16"	5-1/4"	5/8"	Heavy braces
-	-	S91-72	951-170	9-3/16"	5-1/4"	7/8"	Heavy braces
-	-	S91-74	951-57	11-3/4"	6-1/4"	1-1/8"	Heavy braces

PRESSURE GAUGES





PRESSURE

 No.	Ref. No.	Mount	Face	Range	 No.	Ref. No.	Mount	Face	Range
S100-100	146010	1/8" CBM	1-1/2"	0-15 PSI	S100-142	47738	1/4" LM	2-1/2"	0-30 PSI
S100-102	146011	1/8" CBM	1-1/2"	0-30 PSI	S100-144	47495	1/4" LM	2-1/2"	0-60 PSI
S100-104	146013	1/8" CBM	1-1/2"	0-100 PSI	S100-146	45331	1/4" LM	2-1/2"	0-100 PSI
S100-106	49488	1/4" CBM	2"	0-30 PSI	S100-148	48365	1/4" LM	2-1/2"	0-160 PSI
S100-108	47615	1/4" LM	2"	0-15 PSI	S100-150	46913	1/4" LM	2-1/2"	0-200 PSI
S100-110	46644	1/4" LM	2"	0-30 PSI	S100-152	45765	1/4" LM	2-1/2"	0-300 PSI
S100-112	45764	1/4" LM	2"	0-60 PSI	S100-154	49611	1/4" LM	2-1/2"	0-400 PSI
S100-114	45330	1/4" LM	2"	0-100 PSI	S100-156	46648	1/4" LM	2-1/2"	0-600 PSI
S100-116	46912	1/4" LM	2"	0-160 PSI	S100-158	5504	1/4" LM	3-1/2"	0-30 PSI
S100-118	47101	1/4" LM	2"	0-200 PSI	S100-160	5506	1/4" LM	3-1/2"	0-60 PSI
S100-120	46778	1/4" LM	2"	0-300 PSI	S100-162	5508	1/4" LM	3-1/2"	0-100 PSI
S100-122	47492	1/4" LM	2"	0-400 PSI	S100-164	5510	1/4" LM	3-1/2"	0-160 PSI
S100-124	47493	1/4" LM	2"	0-600 PSI	S100-166	5512	1/4" LM	3-1/2"	0-200 PSI
S100-126	52420	1/8" LM	2"	0-15 PSI	S100-168	5514	1/4" LM	3-1/2"	0-300 PSI
S100-128	47490	1/8" LM	2"	0-30 PSI	S100-170	5515	1/4" LM	3-1/2"	0-400 PSI
S100-130	52576	1/8" LM	2"	0-60 PSI	S100-172	5516	1/4" LM	3-1/2"	0-600 PSI
S100-132	47491	1/8" LM	2"	0-100 PSI	S100-174	5551	1/4" LM	4-1/2"	0-60 PSI
S100-134	48302	1/8" LM	2"	0-160 PSI	S100-176	5554	1/4" LM	4-1/2"	0-100 PSI
S100-136	46645	1/8" LM	2"	0-200 PSI	S100-178	5561	1/4" LM	4-1/2"	0-200 PSI
S100-138	48363	1/8" LM	2"	0-300 PSI	S100-180	5563	1/4" LM	4-1/2"	0-300 PSI
S100-140	47102	1/4" LM	2-1/2"	0-15 PSI					

PRESSURE GAUGES - LIQUID FILLED - Stainless steel case



PRESSURE

 No.	Ref. No.	Mount	Face	Range	 No.	Ref. No.	Mount	Face	Range
S100-200	166664	1/8" CBM	1-1/2"	0-30 PSI	S100-238	165295	1/4" CBM	2"	0-1000 PSI
S100-202	166665	1/8" CBM	1-1/2"	0-60 PSI	S100-240	165296	1/4" LM	2-1/2"	0-30 PSI
S100-204	166666	1/8" CBM	1-1/2"	0-100 PSI	S100-242	165297	1/4" LM	2-1/2"	0-60 PSI
S100-206	166667	1/8" CBM	1-1/2"	0-160 PSI	S100-244	165298	1/4" LM	2-1/2"	0-100 PSI
S100-208	166668	1/8" CBM	1-1/2"	0-300 PSI	S100-246	165299	1/4" LM	2-1/2"	0-160 PSI
S100-210	166669	1/8" CBM	1-1/2"	0-1000 PSI	S100-248	165300	1/4" LM	2-1/2"	0-300 PSI
S100-212	165282	1/4" LM	2"	0-30 PSI	S100-250	165301	1/4" LM	2-1/2"	0-600 PSI
S100-214	165283	1/4" LM	2"	0-60 PSI	S100-252	165302	1/4" LM	2-1/2"	0-1000 PSI
S100-216	165284	1/4" LM	2"	0-100 PSI	S100-254	165377	1/4" LM	2-1/2"	0-2000 PSI
S100-218	165285	1/4" LM	2"	0-160 PSI	S100-256	165378	1/4" LM	2-1/2"	0-3000 PSI
S100-220	165286	1/4" LM	2"	0-300 PSI	S100-258	165303	1/4" CBM	2-1/2"	0-30 PSI
S100-222	165287	1/4" LM	2"	0-600 PSI	S100-260	165304	1/4" CBM	2-1/2"	0-60 PSI
S100-224	165288	1/4" LM	2"	0-1000 PSI	S100-262	165305	1/4" CBM	2-1/2"	0-100 PSI
S100-226	165289	1/4" CBM	2"	0-30 PSI	S100-264	165306	1/4" CBM	2-1/2"	0-160 PSI
S100-228	165290	1/4" CBM	2"	0-60 PSI	S100-266	165307	1/4" CBM	2-1/2"	0-300 PSI
S100-230	165291	1/4" CBM	2"	0-100 PSI	S100-268	165308	1/4" CBM	2-1/2"	0-600 PSI
S100-232	165292	1/4" CBM	2"	0-160 PSI	S100-270	165309	1/4" CBM	2-1/2"	0-1000 PSI
S100-234	165293	1/4" CBM	2"	0-300 PSI	S100-272	165380	1/4" CBM	2-1/2"	0-2000 PSI
S100-236	165294	1/4" CBM	2"	0-600 PSI	S100-274	165381	1/4" CBM	2-1/2"	0-3000 PSI

1/4" = 1/4" NPT pipe thread

1/8" = 1/8" NPT pipe thread

CBM = Center back mount

LM = Low mount



LBM = Low back mount

S10

rev. 5-1-05



Please order by  No.

LOW PRESSURE DIAPHRAGM GAUGES

 No.	Ref. No.	Mount	Face	Range	 No.	Ref. No.	Mount	Face	Range
S100-300	161963	1/4" LM	2-1/2"	15" WC	S100-318	161971	1/4" LM	2-1/2"	10 PSI
S100-302	161964	1/4" LM	2-1/2"	35" WC	S100-320	161972	1/4" LM	2-1/2"	20 oz.-35" WC
S100-304	162787	1/4" LM	2-1/2"	60" WC	S100-322	21551	1/4" CBM	2-1/2"	15" WC
S100-306	161965	1/4" LM	2-1/2"	100" WC	S100-324	21552	1/4" CBM	2-1/2"	35" WC
S100-308	161966	1/4" LM	2-1/2"	200" WC	S100-326	75995	1/4" CBM	2-1/2"	60" WC
S100-310	161967	1/4" LM	2-1/2"	20 oz.	S100-328	75991	1/4" CBM	2-1/2"	20 oz.
S100-312	161968	1/4" LM	2-1/2"	32 oz.	S100-330	21553	1/4" CBM	2-1/2"	36 oz.
S100-314	161969	1/4" LM	2-1/2"	36 oz.	S100-332	21554	1/4" CBM	2-1/2"	5 PSI
S100-316	161970	1/4" LM	2-1/2"	5 PSI	S100-334	75996	1/4" CBM	2-1/2"	10 PSI



COMPOUND GAUGES

 No.	Ref. No.	Mount	Face	Range	 No.	Ref. No.	Mount	Face	Range
S100-400	47925	1/8" LM	2"	30"-60 PSI	S100-408	46646	1/4" LM	2-1/2"	30"-60 PSI
S100-402	49609	1/8" LM	2"	30"-150 PSI	S100-410	47411	1/4" LM	2-1/2"	30"-150 PSI
S100-404	75260	1/8" LM	2"	30"-300 PSI	S100-412	58156	1/4" LM	2-1/2"	30"-300 PSI
S100-406	47105	1/4" LM	2-1/2"	30"-30 PSI					



GAUGE ADAPTER

 No.	Description
S100-10	1/4"-NPT (F) x 1/8"-NPT (M) Brass gauge adapter

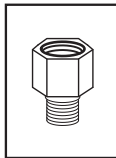

VACUUM GAUGES

 No.	Ref. No.	Mount	Face	Range
S100-498	-	1/8" LM	1-1/2"	0 - 30" Hg
S100-500	47225	1/8" LM	2"	0 - 30" Hg
S100-502	47103	1/4" LM	2"	0 - 30" Hg
S100-504	47104	1/4" LM	2-1/2"	0 - 30" Hg



TEST GAUGES

 No.	Ref. No.	Type	Mount	Face	Range	Refrigerant Scale	For Westwood Tester
S100-280	-	Pressure*	1/8" LM	2"	0 - 300 PSI	-	T10, T11
S100-285	-	Pressure*	1/8" LM	2-1/2"	0 - 300 PSI	-	T20, T22
S100-290	-	Vacuum*	1/8" LM	2"	0 - 30" Hg	-	T15
S100-295	-	Vacuum*	1/8" LM	2-1/2"	0 - 30" Hg	-	T20



* Liquid filled, stainless steel case

1/4" = 1/4" NPT pipe thread
1/8" = 1/8" NPT pipe thread

CBM = Center back mount
LM = Low mount
LBM = Low back mount



PRESSURE & VACUUM TESTERS starting on page T1

Please order by  No.

Westwood
OIL BURNER PUMP STRAINERS & GASKETS
 STAINLESS STEEL MESH • NYLON ENDS • SONICALLY WELDED

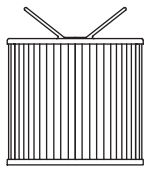
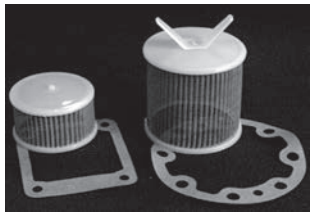

 No. **S150 (Series)**
 Suntec J, H, S



 No. **S160 (Series)**
 Suntec A70

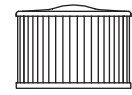

 No. **S170 (Series)**
 Suntec B80, 1-3/8"

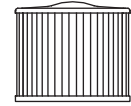

 No. **S180 (Series)**
 Suntec B80, 1-5/8"

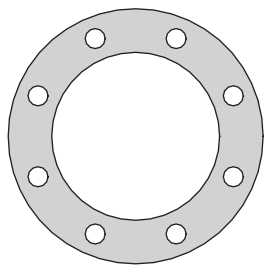

 No. **S150 (Series)**
 Suntec J, H, S

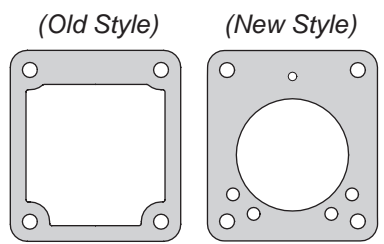

 No. **S190 (Series)**
 Suntec A70 & B80



 No. **S195**
 Riello



 No. **S197**
 Danfoss

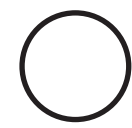

 No. **S195-5**
 Riello

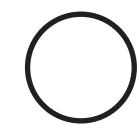

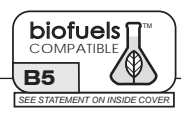

 No. **S197-5**
 Danfoss

 No.	Ref. No.	Description
S150	JHS	Strainer for Suntec J, H, S, individually boxed w/gasket
S150-10	-	Strainer for Suntec J, H, S, individually bagged w/gasket
S150-12	-	"P" Strainer for Suntec J, H, S, high capacity (coarse mesh), individually bagged w/gasket
S150-55	-	Cover gasket for Suntec J, H, S, package of 10 gaskets
S150-60	-	Cover gasket for Suntec J, H, S, package of 50 gaskets
S150-65	-	Cover gasket for Suntec J, H, S, package of 100 gaskets
S160-10	-	Strainer for Suntec A70 single-stage mini pump, individually bagged w/old style gasket
S160-12	-	Strainer for Suntec A70 single-stage mini pump, individually bagged w/new style gasket
S170	-	Strainer for Suntec B80 two-stage mini pump, 1-3/8" long, indiv. boxed w/old style gasket
S170-1	-	Strainer for Suntec B80 two-stage mini pump, 1-3/8" long, indiv. boxed w/new style gasket
S180	-	Strainer for Suntec B80 two-stage mini pump, 1-5/8" long, indiv. boxed w/old style gasket
S180-1	-	Strainer for Suntec B80 two-stage mini pump, 1-5/8" long, indiv. boxed w/new style gasket
S190	-	Cover gasket for Suntec A70 and B80 mini pumps, old style, package of 50 gaskets
S190-1	-	Cover gasket for Suntec A70 and B80 mini pumps, old style, package of 100 gaskets
S190-2	-	Cover gasket for Suntec A70 and B80 mini pumps, old style, package of 10 gaskets
S190-5	-	Cover gasket for Suntec A70 and B80 mini pumps, new style, package of 50 gaskets
S190-6	-	Cover gasket for Suntec A70 and B80 mini pumps, new style, package of 100 gaskets
S190-7	-	Cover gasket for Suntec A70 and B80 mini pumps, new style, package of 10 gaskets
S195	-	Strainer for Riello pump, individually bagged w/'O' ring gasket
S195-5	-	Cover 'O' ring gasket for Riello pump, package of 6 'O' rings
S196	-	Riello strainer w/o-ring and cork gasket
S197	-	Strainer for Danfoss pump, individually bagged w/'O' ring gasket
S197-5	-	Cover 'O' ring gasket for Danfoss pump, package of 6 'O' rings



FUEL SYSTEM PARTS

BY-PASS PLUGS		
 1/16" THREAD For Suntec A, B Webster M	 1/8" THREAD For Suntec J, H Webster R	 METRIC THREAD For RIELLO pump

 No. **S211, -1**

 No. **S211-2, -3**

 No. **S211-4, -5**



 No. **S213 & S214 (Series)**

MILLER FURNACE OIL LINE KIT

- 1 · S213-7 oil line. For Wayne Home Equip. OE, OE-LS, M-LS, MSRH, Nu-Way FM, FM-LS, FS-LS, Beckett AF-15, when burner does not have a Sundstrand A1VA 17J1600 pump.
- 1 · S213-11 oil line. For Wayne Home Equip. OE, OE-LS, Nu-Way FM, FM-LS, when burner has Sundstrand A1VA 17J1600 pump.
- 1 · 1/4" flare x 3/16" flare reducer adapter for certain Wayne OE & OE-LS burners
- 1 · 3/16" flare x 1/8" · NPT elbow for certain Wayne OE & OE-LS burners

 No. **S214-25**

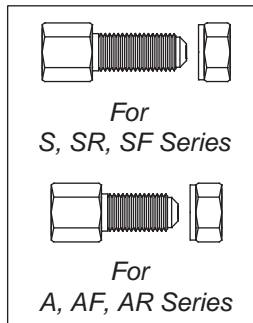

 No. **S215, -1**

MAGIC*PATCH™
FOR TEMPORARY USE ON LEAKING FUEL OIL TANKS

TAKE THE **MAGIC*PATCH™** CHALLENGE

PUT A MAGIC*PATCH AGAINST A REGULAR MAGNETIC PATCH (PAD TO PAD, HELD TOGETHER BY THE MAGNETS) AND LEAVE THEM FOR 24 HOURS. AFTER THAT TIME TEST THE MAGNETS. YOU'LL SEE WHAT MAKES THE MAGIC*PATCH, "MAGIC"

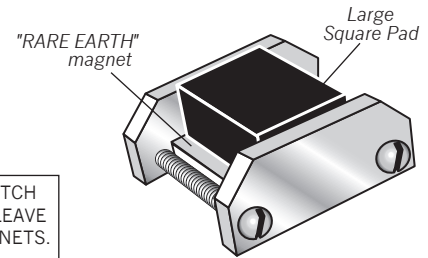

...holds like magic!

 No. **S216**

BY-PASS PLUGS, OIL LINES & FITTINGS, MAGIC-PATCH

 No.	Ref. No.	Description
S211	-	By-Pass Plug for Suntec A, B and Webster M, 1/16"- NPT, package of 10
S211-1	-	By-Pass Plug for Suntec A, B and Webster M, 1/16"- NPT, package of 100
S211-2	-	By-Pass Plug for Suntec J, H and Webster R, 1/8" NPT, package of 10
S211-3	-	By-Pass Plug for Suntec J, H and Webster R, 1/8" NPT, package of 100
S211-4	-	By-Pass Plug for RIELLO pump, (takes 2.5mm hex key), package of 10
S211-5	-	By-Pass Plug for RIELLO pump, (takes 2.5mm hex key), package of 100
S213-5	3605	Nozzle line w/flare nuts, 3/16" O.D. copper tubing, 5" long
S213-7	3607	Nozzle line w/flare nuts, 3/16" O.D. copper tubing, 7" long
S213-8	3608	Nozzle line w/flare nuts, 3/16" O.D. copper tubing, 8" long
S213-11	3611	Nozzle line w/flare nuts, 3/16" O.D. copper tubing, 11" long
S213-12	3612	Nozzle line w/flare nuts, 3/16" O.D. copper tubing, 12" long
S213-16	3616	Nozzle line w/flare nuts, 3/16" O.D. copper tubing, 16" long
S214-12	1412	Nozzle line w/flare nuts, 1/4" O.D. copper tubing, 12" long
S214-16	1416	Nozzle line w/flare nuts, 1/4" O.D. copper tubing, 16" long
S214-25	OL-711	Oil line parts kit for Miller furnaces, (1) S213-7, (1) S213-11, (2) fittings
S215	-	Replacement nozzle line fitting for Beckett S, SR, SF series burners
S215-1	-	Replacement nozzle line fitting for Beckett A, AF, AR series burners
S216	-	MAGIC*PATCH magnetic emergency tank leak patch

Please order by  No.

The Tigerloop[®] Oil De-aerator

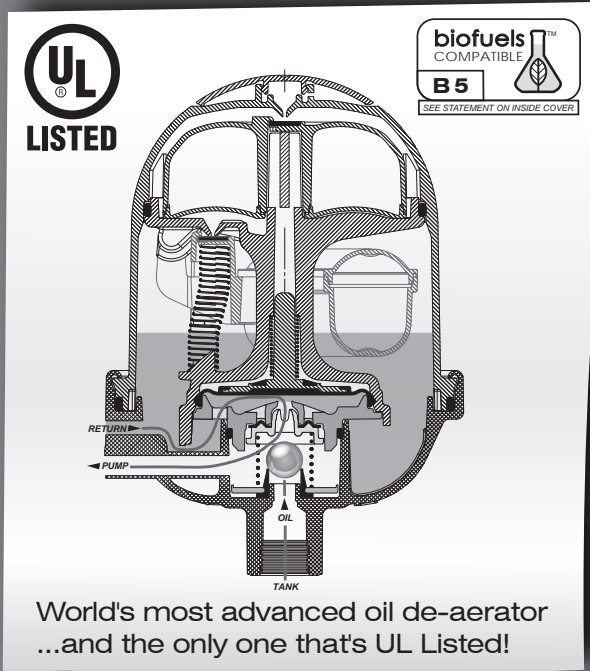

The Tigerloop[®] Oil De-aerator

The Tigerloop[®] is a wonderful device that has many benefits. It is often misunderstood and its workings can be difficult to grasp. Hopefully after reading this you'll come away with at least a basic idea of how the Tigerloop[®] works, and how it can improve the efficiency and extend the life of your oil heating systems.

The Tigerloop[®] combines the benefits of a single pipe system with a two pipe system. With a Tigerloop[®] installed, you need only to transport oil at the nozzle firing rate (i.e. 1 gph). This allows you to use one small line from the tank to the Tigerloop[®], whereas with a 2 pipe installation you have to provision 2 large diameter lines that will handle oil traffic at approximately 20 gph in both directions. One immediate benefit is the cost savings of dropping one line, but there are many more advantages. You filter less oil, 1 gph vs. 20 gph, which extends filter life. You preheat oil because it travels slowly into the house (at 1 gph) and loops through the Tigerloop[®] and pump approx. 20 times, picking up heat before it is fired. Contrast this to a 2 pipe system where cold oil enters the house rapidly (20 gph) and then is immediately sent back outside into the cold tank again (this also stirs up sediment in the tank, which can clog nozzles and filters). With a Tigerloop[®] you also eliminate the risk of a leak from the pressurized return line that is constantly pumping oil back to the tank. You also get a vacuum reduction because you are only pulling 1 gph up the inlet line instead of 20 gph. This is even more critical if you are lifting oil, or have a restricted line or a dirty filter. Imagine trying to pull 20 gph through a small restriction. Installing a Tigerloop[®] cuts the flow rate down to 1 gph, dropping vacuum and improving burner efficiency, while putting less strain on your oil pump and motor. Vacuum pulls vapor right out of the oil even in an "air tight" system. Less vacuum, less air, less problems....higher efficiency.

The Tigerloop[®] takes the good things of a 2 pipe system and improves them. With a 2 pipe system, all of the air and oil in the line flows through the pump, flows by (or out) the nozzle and then gets returned all the way back to the tank. The Tigerloop[®] improves upon this by deaerating the return oil and sending it back to the pump. This can reduce air by 95%. For example if you need 1 gph from the tank, the Tigerloop[®] is supplying 19 gph of de-aerated oil. This means that 19 out of 20 gallons (or 95%) of the oil has been de-aerated, and you get an efficiency bump. The flame will sputter less, the burner will fire cleaner and produce less soot. Soot build-up on the inside of a boiler will interfere with the absorption of heat. With a Tigerloop[®] installed, the heat will be going into the home, instead of up the chimney. In a single pipe system, all air in the line has to go out the nozzle, so installing a Tigerloop[®] will reduce lockouts, flameouts, and sputters. This will give you the efficiency benefits mentioned above.

Now a quick explanation of how the Tigerloop[®] works. Oil gets pulled through a check valve (inside the Tigerloop) and then thru the pump. The pump gives the nozzle what it needs (i.e. 1 gph) and then sends the excess 19 gph back to the Tigerloop[®] to be de-aerated. As oil rises in the Tigerloop[®], air escapes from the top vent until a float lifts and seals the vent. When the vent seals, the Tigerloop[®] builds pressure (about 1/3 psi). The pressure opens a valve sending de-aerated oil back to the pump, creating the loop. If any air reaches the Tigerloop[®], the float drops, the vent opens and the air is removed. The float rises again sealing the Tigerloop[®].

You can see that having a Tigerloop[®] is better than either a single pipe system or a 2 pipe system, and if the Tigerloop[®] saves a service call, you save money (and aggravation). You also improve burner efficiency and gain customer satisfaction, things which are extremely important in today's oil heating marketplace.

S14

Tigerloop® Model TN

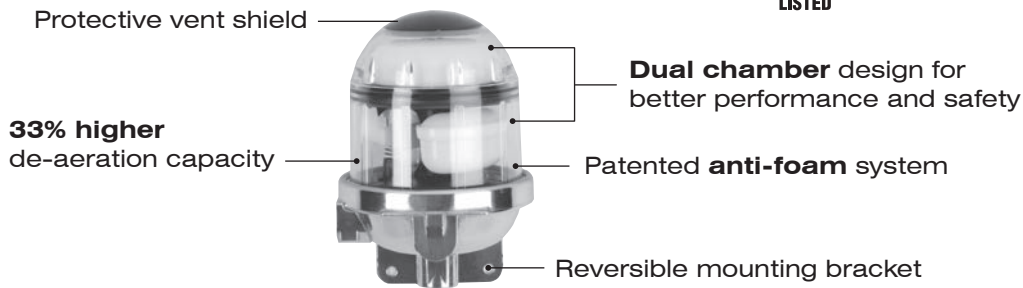

World's most advanced oil de-aerator!

After years of development, the next generation Tigerloop® oil de-aerator has arrived! With over 30 years experience and more than 3.5 million Tigerloops® installed worldwide, Tigerholm is uniquely qualified to take oil de-aeration to the next level.

More than just a problem solver!

For years, Tigerloop® has been primarily thought of as a problem solver, a "band-aid," used to easily cure air and suction line problems. But, that's only part of the story! All systems benefit from Tigerloop's® unique ability to condition the oil prior to burning. Whether it's air elimination, nozzle coking problems, vacuum reduction, oil preheating, or just the elimination of that potentially leaky return line, Tigerloop® is today's safe, economical, environmentally friendly choice for all oil supply systems.

The Advantages of Tigerloop®...

- Safely Handles suction line air leaks.*
- Removes air entrained in oil during transporting and delivery.*
- Reduces running vacuum for clear, foam-free oil at the nozzle.*
- Eliminates potential leak hazard by eliminating the return line.*
- Preheats the oil for cleaner combustion.*
- Extends filter element life.*

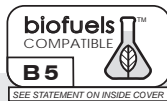

Technical Information

MAX. NOZZLE CAPACITY 29.0 GPH
 MAX. RETURN OIL FLOW 31.7 GPH
 TEMPERATURE RANGE 20° - 105° F
 MAX. INLET PRESSURE 8 PSI
 CONNECTIONS 1/4" - NPT (female)
 FUEL No. 1 & 2 HEATING OIL, B5 BioHeat®
Not for use with E-diesel or any fuel containing Ethanol (alcohol)

 No.	Description
S220*	Tigerloop® oil de-aerator, model TN, UL Listed includes Fiomatic fusible valve.
S220-10	3/8"- NPT Fiomatic fusible valve only w/reducing nipple installed (3/8"- NPT x 1/4"- NPT)
S220-11	Tigerloop® Installation Bundle, oil de-aerator, model TN, UL Listed, w/Fiomatic fusible valve, plus two 36" flexible oil lines.
S220-13	Tigerloop® vent hose kit to re-route vapors.

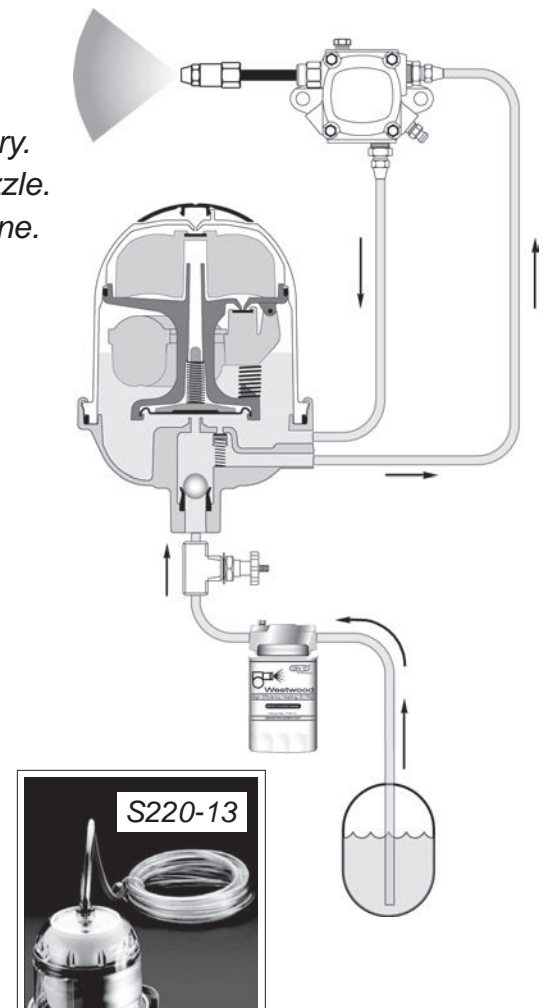

The New

Tigerloop®

ULTRA™

The economical Tigerloop®/Spin-On filter combination that's fast and easy to install. Costs less than installing a Tigerloop® and Spin-On separately! Designed specifically for the demands of American heating systems.

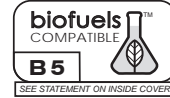

Costs less than installing a Tigerloop® and Spin-On separately!

Technical Information

MAX. NOZZLE CAPACITY 29.0 GPH
 MAX. RETURN OIL FLOW 31.7 GPH
 TEMPERATURE RANGE 20° - 105° F
 MAX. INLET PRESSURE 8 PSI
 CONNECTIONS1/4" - NPT (female)

REPLACEMENT ELEMENT F100-10
 ELEMENT MEDIA 10 Micron
 ELEMENT CANISTER EPOXY INSIDE
 FUEL No. 1 & 2 HEATING OIL, B5 BioHeat®
Not for use with E-diesel or any fuel containing Ethanol (alcohol)

Tigerloop® ULTRA™ OIL DE-AERATOR & SPIN-ON FILTER

 No.	Description
S220-8	Tigerloop® ULTRA™ oil de-aerator & Spin-On filter, UL Listed, includes Fiomatic fusible safety valve.
S220-12	Tigerloop® ULTRA™ Installation Bundle , oil de-aerator, Spin-On filter, UL Listed, w/Fiomatic valve, plus two 36" flexible oil lines.
S220-13	Tigerloop® vent hose kit to re-route vapors (w/30 ft. hose).
F100-10	Replacement Spin-On element only, standard thread, see page F4

Tigerloop® Bio™ **NEW!**

A standard Tigerloop® with B100 compatibility!

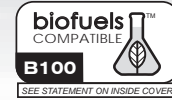

Totally **Metallic** Housing



Technical Information

MAX. NOZZLE CAPACITY 29.0 GPH
 MAX. RETURN OIL FLOW 31.7 GPH
 TEMPERATURE RANGE 20° - 105° F
 MAX. INLET PRESSURE 8 PSI
 CONNECTIONS 1/4" - NPT (female)
 FUEL biofuels up to **B100** BioHeat®, No. 1 & 2 OIL
Not for use with E-diesel or any fuel containing Ethanol (alcohol)

 No.	Description
S220-1	Tigerloop® Bio™ oil de-aerator for biofuels to B100

Tigerloop® ULTRA-B™ **NEW!**

A standard Tigerloop® ULTRA™ with B100 compatibility!

Totally **Metallic** Housing

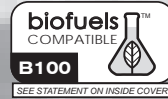

Technical Information

MAX. NOZZLE CAPACITY 29.0 GPH
 MAX. RETURN OIL FLOW 31.7 GPH
 TEMPERATURE RANGE 20° - 105° F
 MAX. INLET PRESSURE 8 PSI
 CONNECTIONS 1/4" - NPT (female)
 REPLACEMENT ELEMENT F100-10
 ELEMENT MEDIA 10 Micron
 ELEMENT CANISTER EPOXY INSIDE
 FUEL . . . biofuels up to **B100** BioHeat®, No. 1 & 2 HEATING OIL
Not for use with E-diesel or any fuel containing Ethanol (alcohol)



 No.	Description
S220-9	Tigerloop® ULTRA™-B oil de-aerator & filter

Tigerloop®

Combi 3™

A European Favorite

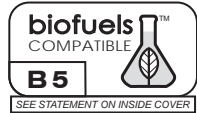

The New **Tigerloop® Combi 3™** now has an integrated shutoff valve. It features a clear plastic bowl which houses a high efficiency sintered plastic filter element with a 50-70 micron rating.

Tigerloop® Combi 3™ OIL DE-AERATOR & FILTER

 No.	Description
S220-3	Tigerloop® Combi 3™ oil de-aerator & filter, 3/8" NPT female tank connection x 1/4" NPT female pump connections.
S220-6	Replacement sintered plastic filter element for S220-3 (Combi 3) & S220-4 (Combi)
S220-7	O-ring for Combi filter cup (Pkg. of 6)

Technical specs are the same as for the S220. See page S15

Tigerloop®

Twin™

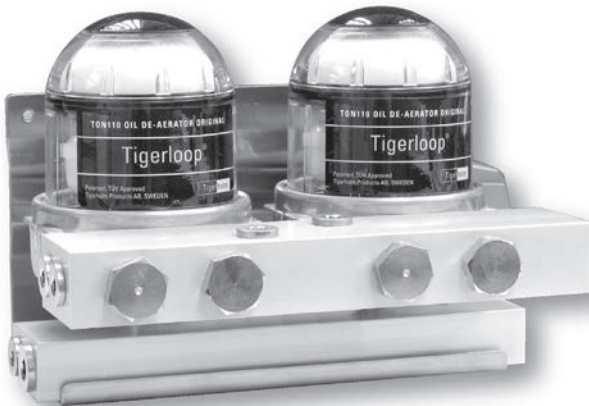

**If something is good...
then two are better!**

The Tigerloop® **Twin™** has twice the capacity for those large commercial jobs. Get all the benefits of Tigerloop's famous de-aeration capabilities...in a bigger way! Comes complete with Westwood's commercial duty Spin-On filter.

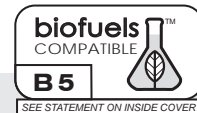

Technical Information

MAX. NOZZLE CAPACITY 52.8 GPH
 MAX. RETURN OIL FLOW 52.8 GPH
 TEMPERATURE RANGE 20° - 105° F
 MAX. INLET PRESSURE 8 PSI
 TANK CONNECTION 3/8" - NPT
 PUMP CONNECTIONS 1/4" - NPT

SPIN-ON FILTER SUPPLIED F100-1
 REPLACEMENT ELEMENT F100-11
 ELEMENT MEDIA 30 Micron
 ELEMENT CANISTER EPOXY INSIDE
 FUEL No. 1 & 2 HEATING OIL, B5 BioHeat®
Not for use with E-diesel or any fuel containing Ethanol (alcohol)

Tigerloop® Twin™ OIL DE-AERATOR & SPIN-ON FILTER

 No.	Description
S220-15	Tigerloop® Twin™ oil de-aerator & commercial duty Spin-On filter
F100-11	Replacement Spin-On element, standard thread, see page F3

GENUINE

Tigerloop®

For use as oil burner pump suction and return lines (not for nozzle line)

FLEXIBLE OIL LINES



For swing-out doors and oil de-aerators

Steel Braided Covering - 24" and 36" Long - 145 PSI - 200 °F
For No. 1 and 2 heating oil, BioHeat® B5 or B20

* DIN ISO 6806 APPROVED

FLEXIBLE OIL LINES, Standard

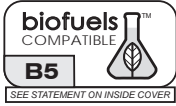
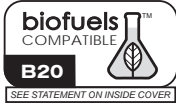
 No.	Description	BioFuels Rating
S220-24	Flexible oil line, braided steel covering, 1/4"- NPT (MxM), 24" long *	 <small>SEE STATEMENT ON INSIDE COVER</small>
S220-36	Flexible oil line, braided steel covering, 1/4"- NPT (MxM), 36" long *	
S220-40	Replacement fitting for flexible oil line, 3/8" inv. flare x 1/4"-NPT	
S222-36	Flexible oil line, braided steel covering, 3/8" Flare (FxF), 36" long *	
S223-24	BioFuels Flexible oil line, braided steel covering, 1/4"- NPT (MxM), 24" long	 <small>SEE STATEMENT ON INSIDE COVER</small>
S223-36	BioFuels Flexible oil line, braided steel covering, 1/4"- NPT (MxM), 36" long	



New!

FLEXIBLE OIL LINES
SPECIAL FOR RIELLO

Color coded Red & Blue for easy identification

European thread connects to **RIELLO** pump adaptor

Easy installation & service with two piece swivel connector

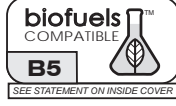

FLEXIBLE OIL LINES, Special for RIELLO burners

 No.	Description	BioFuels Rating
S221-24	Flexible oil line for Riello burner, braided steel outside covering, 1/4"- NPT (M) x 1/4"- BSPP (RIELLO pump adapter thread), 24" long	 <small>SEE STATEMENT ON INSIDE COVER</small>
S221-36	Flexible oil line for Riello burner, braided steel outside covering, 1/4"- NPT (M) x 1/4"- BSPP (RIELLO pump adapter thread), 36" long *	

Service Advisory: All flexible oil lines should be inspected annually for deterioration (i.e. stiffness, cracks, etc.) and replaced every 3 years

 Take a look . . .

For testing RIELLO pumps see page T2 & T3

Please order by  No.

rev. 11-29-17

E-Z Connect ADAPTOR FITTING

One fitting quickly connects the 1/4"-NPT male end of flexible oil lines to 3/8" FLARE!

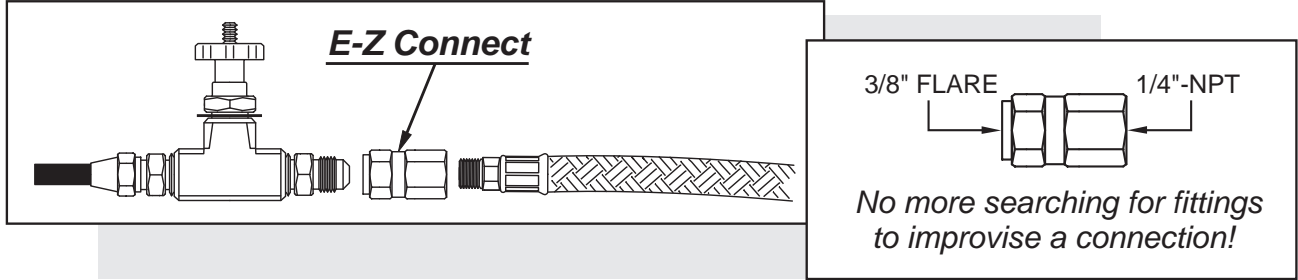

No. S220-50

CHECK VALVES

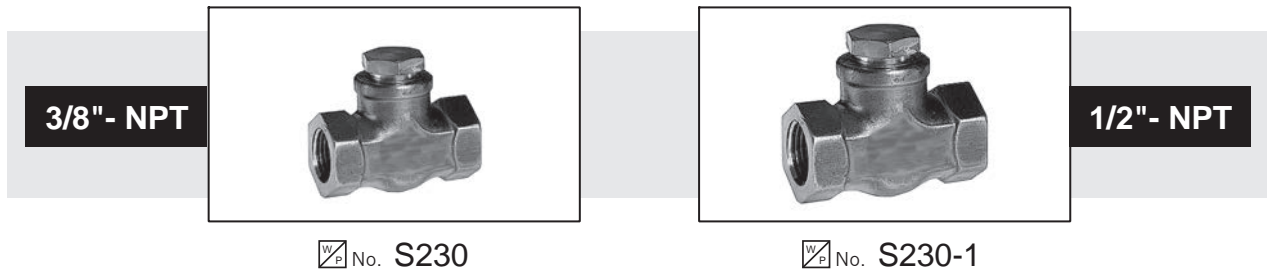

No. S230

No. S230-1

OIL LINE SAFETY VALVES

Isolates burner components from fuel supply line pressure.
Requires pump vacuum to draw oil from the tank.



PRV Oil Line Safety Valve

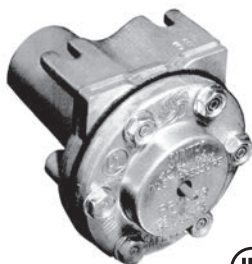

No. S225



Technical Information

MAXIMUM FLOW 20 GPH
TEMPERATURE RANGE 0 - 160° F
MAX. INLET PRESSURE 40 PSI
FUEL No. 2 OR LIGHTER
APPROVAL UL LISTED
CONNECTIONS 3/8"- NPT

Tigerholm

AN SPX BRAND

Tigerstop™ Anti-siphon valve

Adjustable for heights up to 13 ft.



No. S224-2

Technical Information

MAXIMUM FLOW
at 0.58 PSI pressure loss 52.8 GPH
MAX TEMPERATURE 104° F
MAX. INLET PRESSURE 87 PSI
FUEL . biofuels to B20, No.1 & 2 Heating Oil
CONNECTIONS 3/8"- NPT
Height adjustable to 13 ft



Westwood



OIL SAFETY VALVE & SPIN-ON FILTER

Combines the Suntec PRV-38P oil safety valve with the Westwood Products Ultra-10™ (10 micron) high efficiency Spin-On filter element number F100-10. This combination provides the ultimate in protection for oil supply systems and costs less than installing an oil safety valve and Spin-On separately!

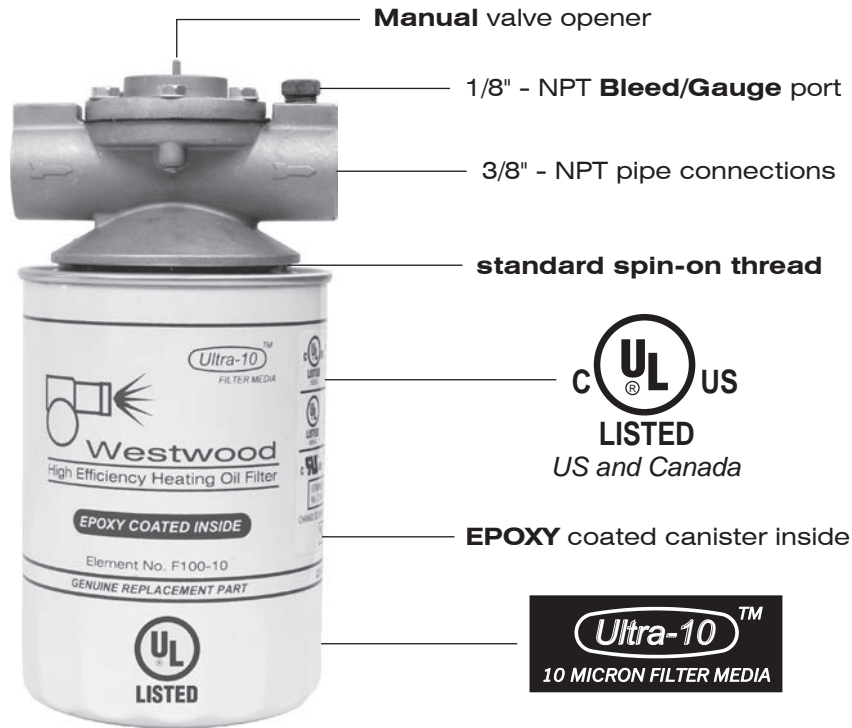

Costs less than installing an Oil Safety Valve and Spin-On separately!

Technical Information

CONNECTIONS 3/8"-NPT	MAXIMUM FIRING RATE 29 GPH
INLET PRESSURE 40 PSI MAX	REPLACEMENT ELEMENT F100-10
TEMPERATURE RANGE 0 - 160° F	ELEMENT MEDIA 10 Micron
FUEL No. 2 OIL OR LIGHTER	ELEMENT CANISTER EPOXY INSIDE
MAXIMUM FLOW 45 GPH	APPROVAL UL LISTED

Westwood OIL SAFETY VALVE & SPIN-ON FILTER



 No.	Description
S226	Westwood oil safety valve and Spin-On filter, UL Listed
F100-10	Replacement Spin-On element, standard thread, see page F3

Westwood

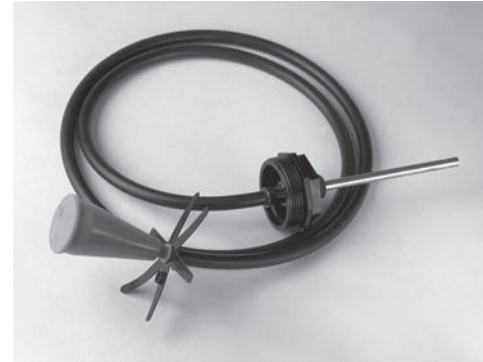
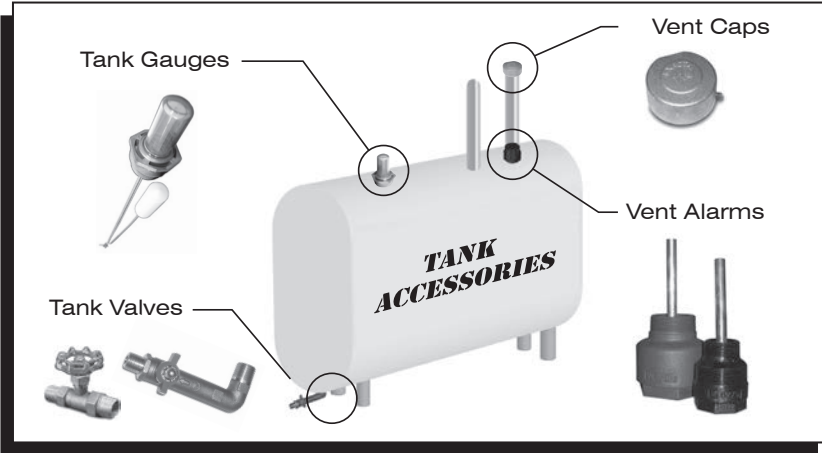
HEATING OIL TANK ACCESSORIES



S260 Tigerflex™ Floating Suction Line

 No.	Description	 No.	Description
S260	Tigerflex™ Floating Suction Line 1-1/2" & 2"	S270-10	2" Aluminum vent cap, set screw, screen
S270	1-1/4" Vent alarm	S270-20	1/2" x 3/8" Oil tank valve, straight
S270-1	2" Vent alarm	S270-22	1/2" x 3/8" Oil tank valve, 90° angle
S270-4	1-1/4" Aluminum vent cap, set screw	S270-24	1-1/2" and 2" Tank gauge, 24"
S270-6	1-1/4" Aluminum vent cap, set screw, screen	S270-44	1-1/2" and 2" Tank gauge, 44"
S270-8	2" Aluminum vent cap, set screw		

S280 Tigex® 150 Draft Stabilizer

Stainless steel design fights soot, moisture, and corrosive chemicals. Gas tight 1100°C superwool seal ensures no leakage of exhaust fumes or ash/soot particles, and quiet function - the damper flap opens and closes quietly during operation as there are no metal parts hitting each other. Easy to install. Self-cleaning door axel. Incredible quality - the top of the line!

Approx Capacity	Max. chimney height	Max. chimney dia. / area
up to 100 kW (341 kBtu)	up to 15 m (49 ft.)	Ø200 mm / 314 cm ² (Ø7-7/8" / 48.7in ²)



Tigex® 150 Draft Stabilizer



Adapter for round flue pipe

Finish Color	Description
Stainless	
S280	Tigex® 150 Draft Stabilizer
S280-130	Adapter for 5" round flue pipe
S280-150	Adapter for 6" round flue pipe
S280-180	Adapter for 7" round flue pipe
S280-200	Adapter for 8" round flue pipe

UNIVERSAL DRAFT REGULATOR

Fits the most popular smoke pipe sizes, 6", 7", 8", galvanized steel.

 No.	Ref. No.	Description
S300-300	#678	3 in 1 combination draft regulator, fits 6", 7", 8" smoke pipe



Westwood

CRANK ARMS - SWIVELS - PUSH RODS

PRECISION MACHINED • HEAVY DUTY • PLATED STEEL

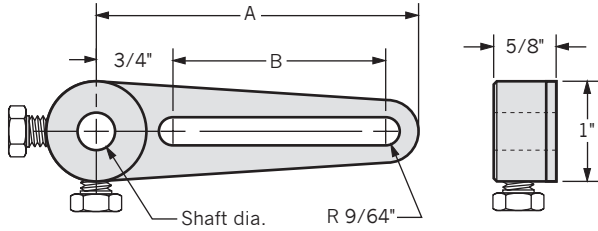

Slotted Crank Arm

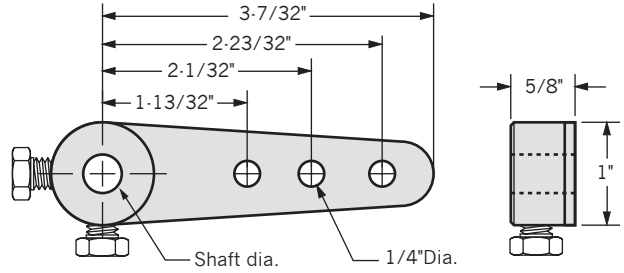

3 Hole Crank Arm

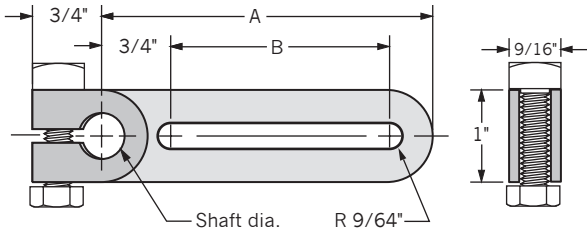

Slotted Crank Arm
(shaft clamping)

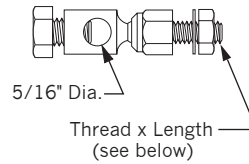

Swivel

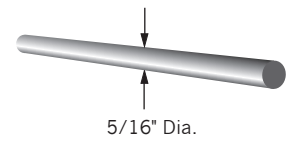

Push Rod

 No.	Ref. No.	Shaft Dia.	A	B	Swivel Thread x Length	Push Rod Length	Description
S300-400	ARM-3S	3/8"	3-3/16"	2-1/8"	-	-	Slotted crank arm
S300-402	ARM-5S	1/2"	3-3/16"	2-1/8"	-	-	Slotted crank arm
S300-404	ARM-3L	3/8"	4-15/16"	3-7/8"	-	-	Slotted crank arm
S300-406	ARM-5L	1/2"	4-15/16"	3-7/8"	-	-	Slotted crank arm
S300-408	ARM-14	3/8"	-	-	-	-	3 hole crank arm
S300-410	ARM-15	1/2"	-	-	-	-	3 hole crank arm
S300-412	ARM-5C	1/2"	3-19/32"	2-3/8"	-	-	Clamping crank arm
S300-414	SW-4	-	-	-	1/4-20 x 7/16"	-	Swivel
S300-416	SW-5	-	-	-	5/16-24 x 41/64"	-	Swivel
S300-418	SW-6	-	-	-	5/16-24 x 33/64"	-	Swivel
S300-420	SW-8	-	-	-	1/4-28 x 9/16"	-	Swivel
S300-422	SW-9	-	-	-	1/4-20 x 9/16"	-	Swivel
S300-424	PR-12	-	-	-	-	12"	5/16" dia. push rod
S300-426	PR-18	-	-	-	-	18"	5/16" dia. push rod
S300-428	PR-24	-	-	-	-	24"	5/16" dia. push rod
S300-430	PR-36	-	-	-	-	36"	5/16" dia. push rod
S300-432	PR-48	-	-	-	-	48"	5/16" dia. push rod

Westwood

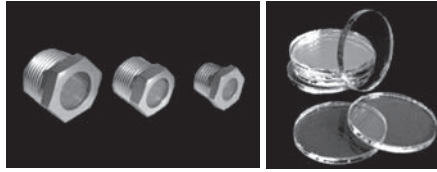

HIGH TEMPERATURE GLASSWARE

BOROSILICATE & SODA LIME WINDOW GLASS

**OBSERVATION PORTS****Clear - Soda Lime Window Glass - Male Pipe Thread Mount - 500° F**

 No.	Reference No.	Pipe Thread	Working Pressure
S305-37	OBS-38	3/8"- NPT	3,700 PSI
S305-50	OBS-50	1/2"- NPT	3,500 PSI
S305-75	OBS-75	3/4"- NPT	3,000 PSI
S305-100	OBS-100	1"- NPT	2,500 PSI
S305-125	OBS-125	1-1/4"- NPT	2,000 PSI
S305-150	OBS-153	1-1/2"- NPT	1,500 PSI

ROUND SIGHT GLASSES - Clear - Borosilicate Glass - 400° F

Diameter	 No.			Diameter	 No.		
	1/8" Thick	3/16" Thick	1/4" Thick		1/8" Thick	3/16" Thick	1/4" Thick
1"	S312-100	S318-100	S325-100	2-5/8"	S312-262	S318-262	S325-262
1-1/8"	S312-112	S318-112	S325-112	2-3/4"	S312-275	S318-275	S325-275
1-3/16"	S312-118	S318-118	S325-118	3"	S312-300	S318-300	S325-300
1-1/4"	S312-125	S318-125	S325-125	3-1/8"	S312-312	S318-312	S325-312
1-3/8"	S312-137	S318-137	S325-137	3-3/16"	S312-318	S318-318	S325-318
1-7/16"	S312-143	S318-143	S325-143	3-1/4"	S312-325	S318-325	S325-325
1-1/2"	S312-150	S318-150	S325-150	3-3/8"	S312-337	S318-337	S325-337
1-5/8"	S312-162	S318-162	S325-162	3-7/16"	S312-343	S318-343	S325-343
1-3/4"	S312-175	S318-175	S325-175	3-1/2"	S312-350	S318-350	S325-350
2"	S312-200	S318-200	S325-200	3-5/8"	S312-362	S318-362	S325-362
2-1/8"	S312-212	S318-212	S325-212	3-3/4"	S312-375	S318-375	S325-375
2-3/16"	S312-218	S318-218	S325-218	4"	S312-400	S318-400	S325-400
2-1/4"	S312-225	S318-225	S325-225	4-1/2"	S312-450	S318-450	S325-450
2-3/8"	S312-237	S318-237	S325-237	5"	S312-500	S318-500	S325-500
2-7/16"	S312-243	S318-243	S325-243	6"	S312-600	S318-600	S325-600
2-1/2"	S312-250	S318-250	S325-250				

Special size round, square, rectangular shapes, and colors available. Consult the factory for price and delivery.

BOILER & FURNACE CLEANING ITEMS

"SERVICE-SAW" BOILER SCALE BUSTING TOOL



Length: 32 in.

 No. S400

"SOOT SABER" BOILER CLEANING TOOLS

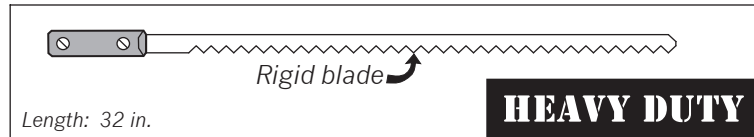

Length: 32 in.

 No. S402

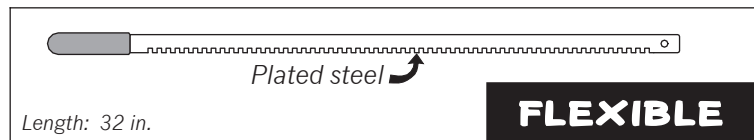

Length: 32 in.

 No. S405

"SOOT SNAKE" VAC HOSE

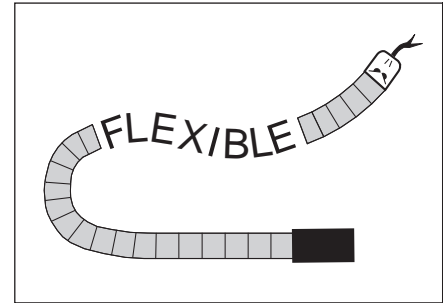

 No. S410

SOOT SHOVEL

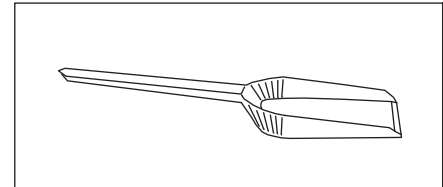

 No. S412

VACUUM CLEANER BAGS - Wrap around seam sealed for strength

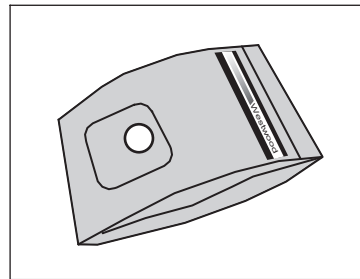

 No. S450-14, -15

When soot's involved, THE SEAM MATTERS!











WHEN BAGS INFLATE, THE ENTIRE FORCE IS PUT ON THE SEAM HOLDING THE BAG TOGETHER. OTHER BAGS RELY ON A GLUED LAP SEAM THAT CAN GIVE WAY UNDER PRESSURE.

WESTWOOD'S SEAM IS ON THE EDGE, WHICH GIVES A STRONGER, WRAP AROUND SEAL.

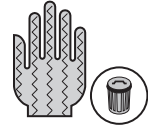
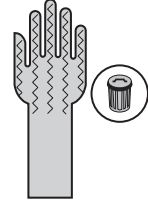
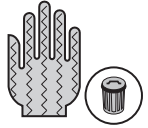
CLEANING TOOLS & VACUUM CLEANER BAGS

 No.	Reference No.	Description
S400	Service-Saw	"Service-Saw" boiler scale cleaning tool, tempered steel saw blade, plastic handle
S402	-	"SOOT SABER" Heavy Duty (rigid) boiler cleaning tool, zinc coated steel, wood handle
S405	-	"SOOT SABER" Flexible boiler cleaning tool, zinc coated steel, soft vinyl handle
S410	-	"SOOT SNAKE" Flexible steel vacuum cleaner hose, 7/8" dia., 48" long, with installed rubber adapter to fit a standard 1-1/2" rubber vacuum cleaner hose
S412	-	Soot Shovel, 4-1/2" wide, 19-1/2" long, steel with black enamel finish
S450-14	-	Style 4464 (3-1/2 gal.) vacuum cleaner bags. Fits Mastercraft 605, 641, 1100, 6500 and others; Sid Harvey S12. Package of 5 bags
S450-15	-	Style 4465 (5 gal.) vacuum cleaner bags. Fits Mastercraft 652, 653, 880, 990, 1005, 1010, 1015, 1200, 7000, 13008, D6508, D6520, D6530, W6508, W6509, W6510, 6513, and others; Sid Harvey S14. Package of 5 bags

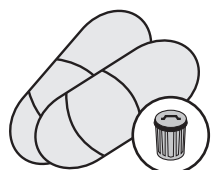
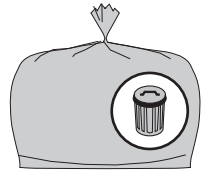
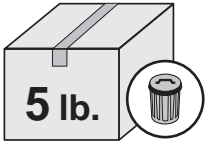
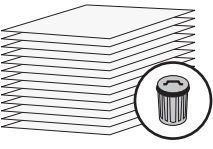
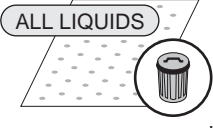
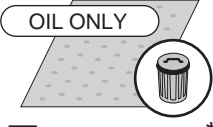
Safety and Spill Cleanup Supplies

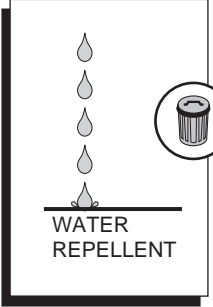
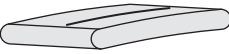
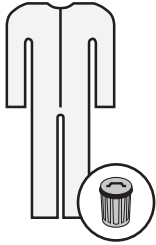
CLOTH	NITRILE GLOVES			MASKS
 <p>No. S500 PAIR Brown jersey gloves man's hand size</p>  <p>No. S500-2 PAIR White canvas gloves cotton/polyester blend man's hand size</p>	 <p>BOX OF 100 Disposable oil resistant blue 5 mil nitrile gloves</p> <p>No. S500-4 LARGE</p> <p>No. S500-6 X-LARGE</p>  <p>No. S500-8* ONE PAIR Reusable heavy duty oil resistant nitrile gloves, man's hand size</p>	 <p>BOX OF 100 MAX-GRIP 6 mil Disposable oil resistant black, 6 mil nitrile gloves, with non-slip textured 4 mil ridges</p> <p>No. S500-5 LARGE No. S500-7 X-LARGE</p> 	 <p>BOX OF 50 MAX-GRIP 7 mil Disposable oil resistant orange, 7 mil nitrile gloves, with non-slip textured 4 mil ridges</p> <p>No. S500-9 LARGE No. S500-11 X-LARGE</p> <p>BOX OF 48 12" LONG NON SLIP GRIP Disposable oil resistant yellow 6 mil nitrile gloves, with non-slip textured 4 mil ridges</p> <p>No. S500-13 LARGE No. S500-15 X-LARGE</p>	 <p>EACH Disposable dust mask, elastic strap</p> <p>No. S500-10 not rated</p> <p>No. S500-12 N95 rated</p>
				GLASSES
				 <p>PAIR Safety Glasses adjustable, plastic</p> <p>No. S500-14 clear lenses</p> <p>No. S500-16 smoked lenses</p>
GOGGLES	SHOE COVERS	BAGS	RAGS	WIPES
 <p>No. S500-18* EACH Plastic splash goggles, elastic strap</p>	 <p>No. S500-20 PAIR Disposable non-woven fabric slip-on shoe covers</p>	 <p>No. S500-22* PACKAGE OF 20 7 bu. plastic (3 mil.) contractor disposal bags</p>	 <p>No. S500-24 Rags (t-shirt mat'l) mixed colors</p> <p>No. S500-25 Rags 18" x 18" white cotton</p>	 <p>No. S500-26 PACKAGE OF 100 Flat paper wipes, 13" x 13"</p>
PADS	SOCKS	DROP CLOTH	SPILL KIT	COVERALLS
<p>ALL LIQUIDS</p>  <p>No. S500-28* PACKAGE OF 100 Absorbent pads 15" x 18" x 1/8" thick</p> <p>OIL ONLY</p>  <p>No. S500-30* PACKAGE OF 100 Absorbent pads 15" x 18" x 1/8" thick</p>	<p>ALL LIQUIDS</p>  <p>No. S500-32* PACKAGE OF 40 Absorbent socks 3" dia. x 48" long</p> <p>OIL ONLY</p>  <p>No. S500-34* PACKAGE OF 40 Absorbent socks 3" dia. x 48" long</p>	<p>5' x 8' (Approximately)</p>  <p>No. S500-36 EACH Large non-woven fabric drop cloth, water repellent</p>	 <p>Spill Kit in Heavy Duty Zippered Carrying Bag</p> <p>Contains:</p> <ul style="list-style-type: none"> 1 - splash goggles 1 - pr. nitrile reusable gloves 2 - contractor bags 1 - All liquid absorbent sock 1 - Oil only absorbent sock 5 - All liquid absorbent pads 5 - Oil only absorbent pads 1 - Heavy duty clear plastic zippered carrying bag <p>No. S500-38 EACH Economy Spill Kit in zippered carrying bag</p>	 <p>Full Body Coverall Disposable, white non-woven fabric</p> <p>No. S500-50 LARGE</p> <p>No. S500-60 X - LARGE</p>

* Part of the S500-38 Economy Spill Kit (see listing above for quantities of each included in the kit).