



# UNITED BRASS WORKS, INC

714 S. Main St.. Randleman, N.C. 27317

Phone: 800/334-3035 Fax: 800/498-4696 [www.ubw.com](http://www.ubw.com)



## Model 525 Slow Opening Blow-Off Valve

Class 300 \* ANSI B 16.34 \* 665 psi Working Steam Pressure @ 500 F

750 psi @ 100 F \* 100% Pressure Tested \* Threaded Ends \* Epoxy Coated (E-Coat)

Max Pressure for Boiler Blow off 530 PSI

CRN OCO7135.2, 24, 25, 26

CRN OEO2171.7, 79, 70, 78, 7AY, 7T, 7N

The United Brass slow opening boiler blow off valve has been designed for the rugged service of boiler treatment and scale. The cast steel knife gate valve conforms to Class 300 of ANSI B16.34 and features a stainless steel seat and disc hardened to Rockwell 60. ASME Boiler and Pressure Vessel Code Section 1 PG-42.1.12 and Power Piping Code ASME B 31.1 Table 126.1 reference steel valves to ANSI B 16.34. The sliding disc provides a “cleaning” action that keeps the seating area clear of scale and debris.

DESCRIPTION	MATERIAL
Body	Steel A216 WCC
Cover	Steel A216 WCC
Gasket	Tanged Graphite
Disc Spring	17-7 Stainless Steel
Disc Rivet	Carbon Steel
Disc	440C Stainless Steel
Arm	Steel A216 WCC
Stem	410 Stainless Steel
Stem Rivet	Carbon Steel
Stem Spring	17-7 Stainless Steel
Packing	Graphite
Packing Nut	410 Stainless Steel
Handle (1" & 1 1/4")	Ductile Iron 65-45-12
Handle (1 1/2" & 2")	Steel A216 WCC
Cotter Pin	Plated Steel
Body Bolts	Steel Grade 8
Hex Nuts	Steel Grade 8
Name Plate	Stainless Steel
Drive Screws	Stainless Steel
Operating Assembly	Bronze

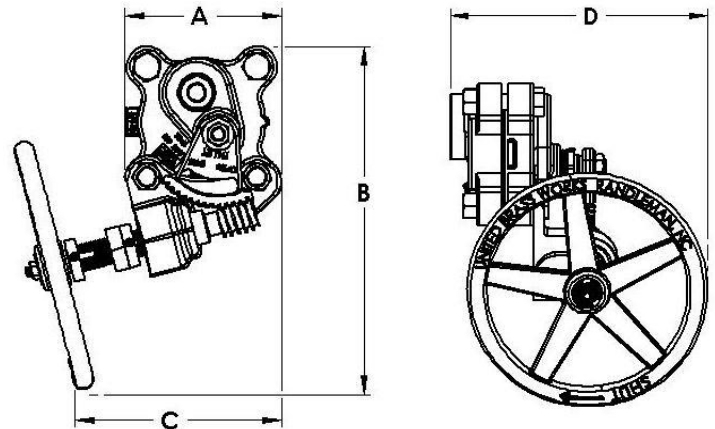
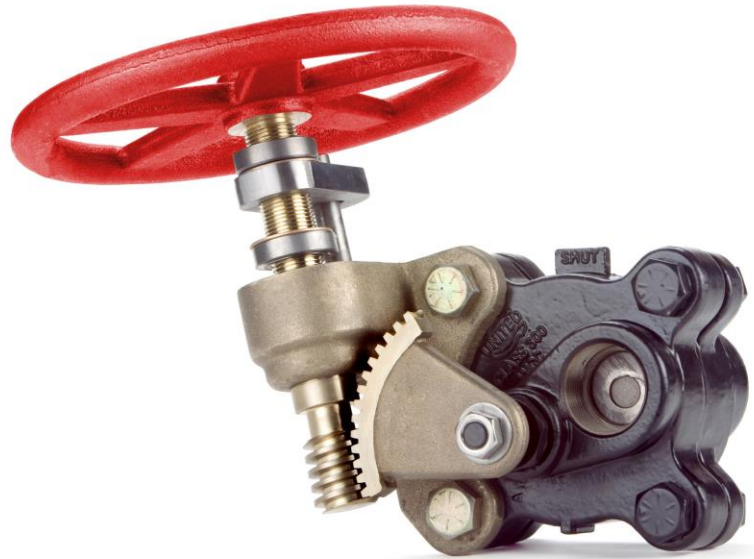

Size	1	1 1/4"	1 1/2"	2"
A	5.50	5.50	7.80	9.20
B	12.30	12.30	14.30	14.90
C	9.50	9.50	10.60	16.00
D	9.60	9.60	10.20	11.50
Weight	26.0	26.0	40.0	68.0