



UNITED BRASS WORKS, INC.

714 S. Main St. Randleman, N.C. 27317

Tel: 800-334-3035 Fax: 800-498-4696 www.ubw.com



Model 62 Swing Check Valve

Complies with MSS-SP-80-2013

CRN OCO7135.2C

200WSP @ 406° Max

400 WOG

100% Pressure Tested

Threaded Ends

Contains Lead. Not Intended for Use in Potable Water Systems

Install in horizontal position with cap in upright position.

Not recommended for pulsating or vibrating service.



When used on Boiler feed line it is recommended that a #50T spring loaded check valve be used in conjunction with #62 with the #62 located nearest to the boiler and the #50T located nearest to the pump.

MATERIAL LIST

NO.	DESCRIPTION	MATERIAL
1	Cap (1/4" - 3/4") Cap (1" - 3")	Brass Bronze
2	Hinge Pin	Brass
3	Hinge	Stainless Steel
4	Body	Bronze
5	Disc	Bronze
6	Disc Nut	Brass

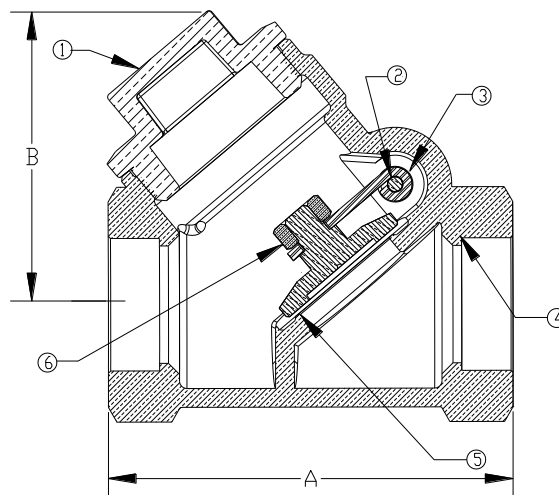

Size	1/4"	3/8"	1/2"	3/4"	1"	1 1/4"	1 1/2"	2"	3"
A	2.38	2.53	2.66	3.09	3.53	5.13	5.13	5.56	9.13
B	1.53	1.53	1.53	1.88	2.09	3.63	3.63	4.56	5.58
Ship Wgt. (lbs.)	0.75	0.81	0.76	1.19	1.73	5.75	5.75	10.00	29.00
Qty. Per Ctn.	12	12	12	12	6	2	2	1	1