



# UNITED BRASS WORKS, INC.

714 S. Main St. Randleman, N.C. 27317

Tel: 800-334-3035 Fax: 800-498-4696 www.ubw.com



## Model 63 Swing Check Valve

Complies with MSS-SP-80-2013

CRN 0C07135.2C

300 WSP

600 WOG

100% Pressure Tested

Threaded Ends

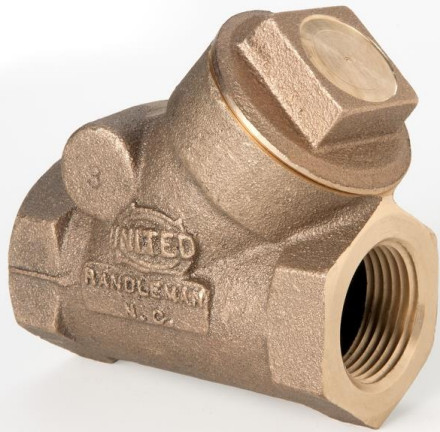

**\*Contains lead. Not Intended for Use in Potable Water Systems\***

*Install in horizontal position with cap in upright position.  
Not recommended for pulsating or vibrating service.*

### MATERIAL LIST

NO.	DESCRIPTION	MATERIAL
1	Cap (1/2 - 3/4") Cap (1" - 3")	Brass Bronze
2	Disc Nut	Bronze
3	Hinge Pin	Brass
4	Body	Bronze
5	Hinge	Stainless Steel
6	Disc	Bronze

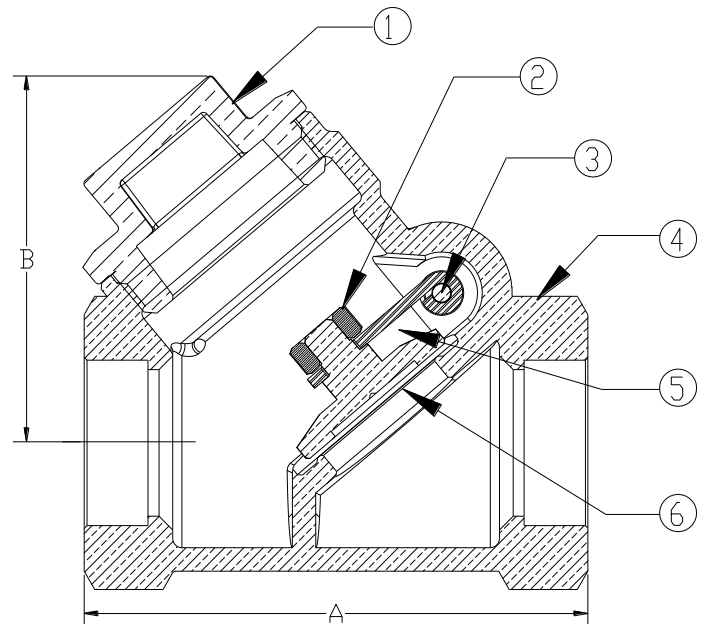

Size	1/2"	3/4"	1"	1 1/4"	1 1/2"	2"	3"
A	2.66	3.09	3.53	5.13	5.13	5.56	9.13
B	1.53	1.88	2.09	3.63	3.63	4.56	5.58
Ship Wgt. (lbs.)	0.76	1.19	1.73	5.75	5.75	10.00	29.00
Qty. Per Ctn.	12	12	6	2	2	1	1